

## DE PALMA dal 1978

**Esperti nel settore** autoricambistico già dai primi decenni del 1900 grazie al nonno "CRISTOFORO DE PALMA", decano del commercio barese artefice della ditta "CRISTOFORO DE PALMA E FIGLI" autoricambi, accessori e officina rettifica per auto autotreni , continuiamo con immutato entusiasmo e professionalità.

L'attività specifica nel settore della viteria e articoli tecnici ha origini con nostro padre FRANCESCO DE PALMA nel **1978**, che già nei primi anni del 1950 si qualificò quale importatore di auto RENAULT, DKW, CITROËN, PANARD, BMW, con annesso negozio di ricambi e officina di riparazione specializzata in auto straniera .

La nostra azienda perciò è **un sicuro punto di riferimento** per qualità e serietà nonché competenza e cortesia.

Presso i nostri magazzini, di oltre 1000 mq. potrete trovare la più ampia disponibilità di:

**VITERIA NORMALE E SPECIALE, MATERIALE PER INGRASSAGGIO , PNEUMATICA, UTENSILERIA, SPRAY TECNICI, DETERGENTI, SGRASSANTI, ANTINFORTUNISTICA, SOLLEVAMENTO E ACCESSORI , RUOTE INDUSTRIALI, MINUTERIA AUTORICAMBISTICA, ARTICOLI TECNICI IN PLASTICA, SISTEMI DI MAGAZZINAGGIO , ARTICOLI PER LA DISINFESTAZIONE , LAMPADE AUTO , LAMPADE A LED PER USO CIVILE E INDUSTRIALE , ARTICOLI TECNICI VARI .**

La nostra **competenza** e la nostra **organizzazione** ci permettono di seguire con scrupolosità, efficienza e massima celerità le richieste dei clienti, anche per la realizzazione e ricerca di articoli particolari o a disegno .

La testimonianza del raggiungimento degli standards di qualità è rappresentata dal riconoscimento che tutta la nostra clientela ci ha dimostrato nel corso degli anni preferendoci alle ditte concorrenti, anche nei momenti commercialmente non facili per tutti.

Ultimo traguardo raggiunto dalla DE PALMA TRADE è il riconoscimento della certificazione UNI EN ISO 14001 Sistema di Gestione Ambientale.



DE PALMA TRADE srl  
S.P. 231 Km 0,850 – MODUGNO ( BA )  
080 532 77 24 // 080 532 71 98  
WWW. DEPALMATRADE.IT  
INFO@DEPALMATRADE.IT



# LUBRIFICAZIONE



**INGRASSATORI**  
pag. 1 - 2 - 3  
**ASSORTIMENTI pag 59**



**TESTINE**  
pag. 4 - 5



**POMPE INGRASSAGGIO**  
pag. 6



**GRASSI**  
pag. 7 - 8



**SIRINGHE OLIO**  
pag. 9



**TUBI GRASSO**  
pag. 10



**POMPE GRASSO / OLIO**  
pag. 11



**AEROPULSOMETRI**  
pag. 12



**AVVOLGITUBO**  
pag. 13



**CARRELLI PER FUSTI**  
pag. 13



**PISTOLE TRAVASO**  
pag. 14



**TUBI GASOLIO**  
pag. 15



**GRUPPI TRAVASO**  
pag. 16



**CONTALITRI**  
pag. 17



**UREA**  
pag. 18



**RECUPERATORI**  
pag. 19



**VASCHE RACCOLTA**  
pag. 19



**NEBULIZZATORI**  
pag. 20



**PISTOLE DISTRIBUZ.**  
pag. 21



**OLIATORI**  
pag. 22



**POMPE TRAVASO**  
pag. 23



**LIVELLI / TAPPI SFIA. IMBUTI / RECIPIENTI**  
pag. 24 - 25

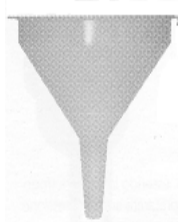

**pag. 26**



**TANICHE**  
pag. 27



**TANICHE**  
pag. 27

**DE PALMA TRADE SRL**

080 532 71 98 // 080 532 77 24

WWW.DEPALMATRADE.IT - INFO@DEPALMATRADE.IT



# PNEUMATICA

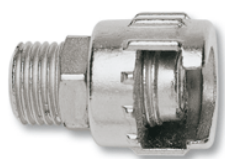

**RACCORDERIA**  
pag. 29 - 30

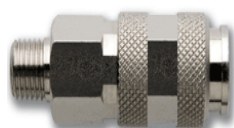
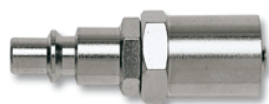

**VALVOLE**  
pag. 31



**INNESTI**  
pag. 31

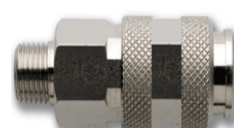

**SERIE GIGANTE**  
pag. 32

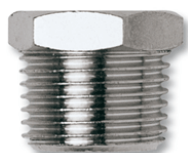

**RIDUZIONI**



**MANICOTTI**  
pag. 33



**RACCORDERIA VARIA**  
pag. 34 - 35



**RACCORDERIA PER TUBI PLASTICI**  
pag. 36 - 37



**RUBINETTI**  
pag. 38



**RACCORDERIA AUTOMATICA**  
pag. 39 - 40



**TUBI PLASTICI / GOMMA PASSAGGIO ARIA**  
pag. 41 - 42

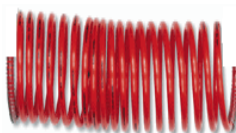
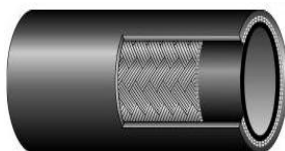

**TUBI SPIRALATI**  
pag. 43



**KIT AUTOCARRO**  
pag. 43



**PISTOLE ARIA**  
pag. 44



**PISTOLE LAVAGGIO**  
pag. 45



**AEROGRAFI**  
pag. 45



**GONFIAGOMME**  
pag. 46



**GRUPPI ARIA**  
pag. 47 - 48 - 49



**MANOMETRI**  
pag. 50

**DE PALMA TRADE SRL**

080 532 71 98 // 080 532 77 24

WWW.DEPALMATRADE.IT - INFO@DEPALMATRADE.IT







# ARTICOLI TECNICI

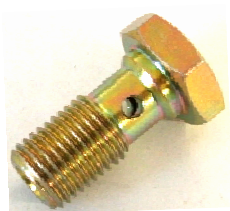

**RACCORDI FORATI BICCHIERE / DURAL RAME / ALLUMINIO**  
pag. 89



**TAPPI**  
pag. 90



**RONDELLE**  
pag. 91



**GUARNIZ. BONDED**  
pag. 92



**RONDELLE BOMBATE / CONICHE**  
pag. 93

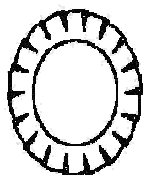

**RONDELLE DENTELLATE / GREMBIALINA**  
pag. 94 - 95

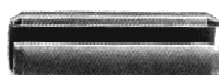

**SPINE ELASTICHE**  
pag. 96



**SPRAY LUBRIFICANTI / PROTETTIVI**  
pag. 97 - 98 - 99



**GRASSI**  
pag. 100



**DETERGENTI SGRASSANTI**  
pag. 101

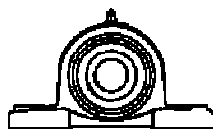

**SUPPORTI GHISA**  
pag. 102

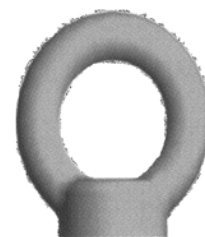

**GOLFARI / TENDITORI / MORSETTI / GRILLI**  
pag. 103 - 104 - 105 - 106 - 107

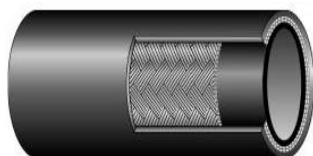

**TUBI GOMMA PER CARBURANTI / ARIA / RADIATORE / IRRORAZIONE / PVC BENZINA**  
pag. 108 - 109 - 110



**VITI PER MACCHINE AGRICOLE**  
pag. 111 - 112 - 113 - 114



**DISINFESTAZIONE**  
pag. 115



**LAMPADIE AUTO - CASA LED**  
pag. 116 - 117



**DE PALMA TRADE SRL**

080 532 71 98 // 080 532 77 24

WWW.DEPALMATRADE.IT - INFO@DEPALMATRADE.IT

# INGRASSATORI A TESTA ESAGONALE

**MATERIALE : ACCIAIO ZINCATO**

Art. **G 3**

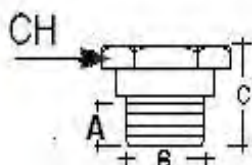

A	B	C	CH
sistema metrico			
6	6 x 1 - 7 x 1 - 8 x 1	13,5	15
6	8 x 1,25 - 10 x 1	13,5	15
6	10 x 1,5 - 12 x 1,75	13,5	15
sistema gas			
6	1/8 - 1/4	13,5	15

**UNI 7662 A**

**CONFEZIONI DA 100 Pz**

Art. **G 9**

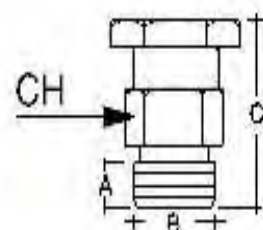

A	B	C	CH
sistema metrico			
7	8 x 1 - 8 x 1,25	18	15
7	10 x 1 - 10 x 1,25	18	15
7	10 x 1,5 - 12 x 1,25	18	15
7	12 x 1,5 - 12 x 1,75	18	15
sistema gas			
7	1/8 - 1/4	18	15

**UNI 7662 B**

**CONFEZIONI DA 50 Pz**



# INGRASSATORI A PUNTA

**MATERIALE : ACCIAIO ZINCATO**

Art. **G 29**

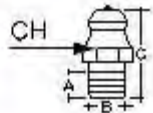

confezione	A	B	C	CH
<b>100 pz</b>	<b>sistema metrico</b>			
	5.5	6 x 1	14	7

**UNI 7663 A -- DIN 71412 A**

Art. **G 30**

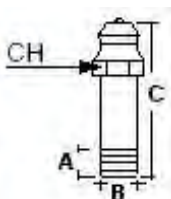

confezione	A	B	C	CH
<b>50 pz</b>	<b>sistema metrico</b>			
	5	6 x 1	28	7

Art. **G 32**

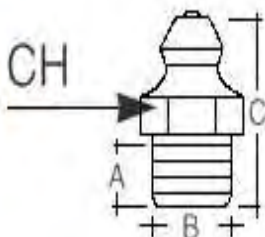

**confezione 100 pz**

A	B	C	CH
<b>sistema metrico</b>			
6	6 x 1 - 7 x 1 - 8 x 1	17	11
6	8 x 1,25    10 x 1	17	11
6	10 x 1,25    10 x 1,5	17	11
<b>sistema gas</b>			
6	1/8	17	11

**UNI 7663 A -- DIN 71412 A**

Art. **G 33**

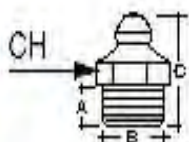

confezione	A	B	C	CH
<b>50 pz</b>	<b>sistema metrico</b>			
	7	12 x 1,5    12 x 1,75	18	14
<b>50 pz</b>	<b>sistema gas</b>			
	7	1/4	18	14





# INGRASSATORI A PUNTA

**MATERIALE : ACCIAIO ZINCATO**

Art. **G 34**



confezione	A	B	C	CH	GRADI
	<b>sistema metrico</b>				
50 pz	6	6 x 1 - 8 x 1 - 8 x 1,25	26	11	45 °
50 pz	6	10 x 1    10 x 1,25	26	11	45 °
50 pz	6	10 x 1,5	26	11	45 °

**UNI 7663 B -- DIN 71412 B**

Art. **G 35**

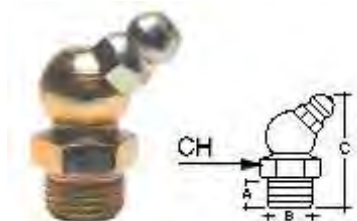

confezione	A	B	C	CH	GRADI
	<b>sistema metrico</b>				
50 pz	6	12 x 1,5    12 x 1,75	26	14	45 °
	<b>sistema gas</b>				
50 pz	6	1/4	26	14	45 °

Art. **G 36**

**UNI 7663 C -- DIN 71412 C**

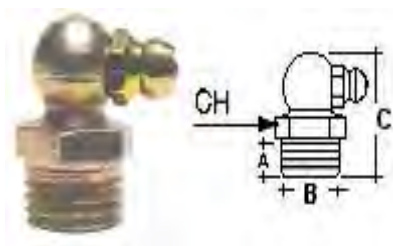

confezione	A	B	C	CH	GRADI
	<b>sistema metrico</b>				
50 pz	6	6 x 1 - 8 x 1 - 8 x 1,25	20	11	90 °
50 pz	6	10 x 1    10 x 1,25	20	11	90 °
50 pz	6	10 x 1,5	20	11	90 °
	<b>sistema gas</b>				
50 pz	6	1/8 -	20	11	90 °
	<b>sistema SAE</b>				
50 pz	6	1/4	20	11	90 °

Art. **G 37**

**UNI 7663 C -- DIN 71412 C**

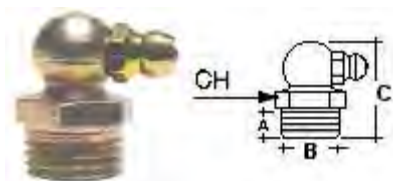

confezione	A	B	C	CH	GRADI
	<b>sistema metrico</b>				
50 pz	6	12 x 1,5    12 x 1,75	20	14	90 °
	<b>sistema gas</b>				
50 pz	6	1/4	20	14	90 °

Art. **TAPPO**

**TAPPO IN NYLON PER INGRASSATORI A PUNTA**



conf. 100 pz



## TESTINE PER INGRASSATORI a TESTA ESAGONALE

Art. **G 99**

UNI 7667

Testina a gancio in ottone nichelato , per ingrassatori a testa esagonale mm 15

Attacco 10 x 1

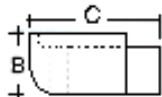

B	C
22	29

Adatta per  
G 3 - G 9

Art. **G 100**

Testina a gancio in ottone nichelato , per ingrassatori a tesata esagonale mm 15

Tipo converso .

Attacco 10 x 1

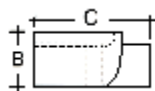

B	C
25	35

Adatta per  
G 3 - G 9

## TESTINE PER INGRASSATORI a TESTA TONDA

Art. **G 101**

Testina a gancio in ottone nichelato , per ingrassatori a tesata tonda mm 22

Attacco 10 x 1

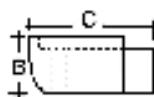

B	C
27	32

Art. **G 101 B**

Testina in acciaio per cingoli ingrassatori a testa tonda mm 22

Attacco 10 x 1

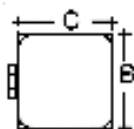

B	C
38	38



## TESTINE PER INGRASSATORI A PUNTA

Art. **G 104**



Testina a 3 griffe per ingrassatori hydraulic .

Attacco 10 x 1

**Adatta per ns.**

G 29 - G 30 - G 32

G 33 - G 34 - G 35

G 36 - G 37

Art. **G 104 Extra**

Testina extra a 4 griffe temperate **REGOLABILE** per ingrassatori hydraulic

Avvitare il terminale zigrinato per una presa tenace, svitare per una presa morbida  
Sgancio semplice mediante movimento rotatorio



Attacco 10 x 1

**Adatta per ns.**

G 29 - G 30 - G 32

G 33 - G 34 - G 35

G 36 - G 37

Art. **G 105**

Testina a gomito 90 °per ingrassatori hydraulic



Attacco 10 x 1

**Adatta per ns.**

G 29 - G 30 - G 32

G 33 - G 34 - G 35

G 36 - G 37





## COMPRESSORI A LEVA per grasso

Art. **G 73**

Compressore a leva caricamento manuale

Max pressione uscita **250 Atm**



Art. Capacità

**G 73 / 0** 300 gr

**G 73 / 1** 500 gr

**G 73 / 2** 750 gr

**G 73 / 3** 1000 gr

Art. **G 73 / C**

Compressore con ricarica a cartuccia o a grasso sfuso



IL KIT COMPRENDE :

Compressore  
Tubo alta pressione  
Testina extra  
Cartuccia grasso al litro 600 gr

Art. **G 310**

Compressore pneumatico con ricarica a cartuccia o a grasso sfuso



IL KIT COMPRENDE :

Compressore  
Tubo alta pressione  
Testina 4 griffe  
1 Cartuccia grasso al litro 600 gr

Max pressione entrata **5 - 8 Atm**

Max pressione uscita **250 Atm**



# GRASSO IN CARTUCCE

Grasso a base di sapone di Litio in cartucce da 650 cm<sup>3</sup> - diametro 55 mm

Art. **G 311** Confezione di 30 pz cartucce grasso per art G 73/ C - G 310



Incluso compressore ns. G 73 / C

Art. **G 312** Confezione di 12 pz cartucce grasso per art G 73/ C - G 310



Si consiglia l'uso con i ns. kit ingrassaggio Art G 73/ C - G 310

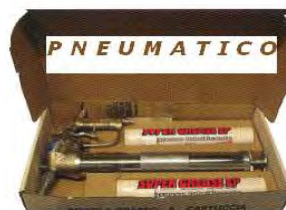

## GRASSO IN BARATTOLI

Grasso professionale a base di saponi di Litio

Punto di goccia > 185°C

Temperatura ottimale d'impiego: da -20°C a +130°C

Resistente agli alti carichi

Art. **0701**

BARATTOLO 1 Kg

Art. **0705**

SECCHIO 5 Kg

Art. **0720**

SECCHIO 20 Kg



## GRASSO SPRAY

Art. **0572**

BOMBOLETTA DA 400 ML





## SIRINGHE PER GRASSO

Art. **G 76**

Siringa a pressione in acciaio tipo rientrante per grasso con puntalino **ZERCH**



Art.	Contenuto
<b>G 76 / 2</b>	50 gr
<b>G 76 / 3</b>	200 gr

## SIRINGHE PER OLIO

Siringa per olio aspirante / premente

Art. **G 80 / O** Ottone

Art. **G 80 / A** Acciaio



Art. Ottone	Contenuto	Art. Acciaio	Contenuto
<b>G 80 / O 1</b>	125 gr	<b>G 80 / A 2</b>	250 gr
<b>G 80 / O 2</b>	250 gr	<b>G 80 / A 3</b>	500 gr
<b>G 80 / O 4</b>	500 gr	<b>G 80 / A 4</b>	1000 gr
<b>G 80 / O 5</b>	1000 gr		

Art. **G 81**

Siringa per olio **cambio differenziale** in acciaio



Capacità 500 gr



## TUBI PASSAGGIO GRASSO PER COMPRESSORI MANUALI

Art. **G 86**

Attacco rigido in acciaio -- Filetto 10 x 1



Art. **G 94**

Tubo alta pressione in **gomma** - Raccordi pinzati M 10 x 1  
per ns. art . G 73 - G 73 / C - G 310

Pressione max. 60 Bar

Raccordi maschi 10 x 1

Art.	Lunghezza
G 94 / 40	40 cm
G 94 / 50	50 cm
G 94 / 60	60 cm
G 94 / 70	70 cm
G 94 / 100	100 cm
G 94 / 120	120 cm



Art. **G 252**

Tubo alta pressione per pompa a barile art. G 150  
Attacco M 16 x 2 - F 10 x 1



Art.	Lunghezza
G 252/1	1,5 mt
G 252/2	2 mt
G 252/3	2,5 mt
G 252/4	3,5 mt
G 252/5	4,5 mt



## POMPE A BARILE PER GRASSO E OLIO

Art. **G 150** Pompa a barile per grasso



### Completa di

Tubo a.p. mt 1,5 ( Art. G 252 / 1 )  
Attacco rigido ( Art. G 86 )  
Testina 4 griffe  
Rubinetto

Art.	Capacità
------	----------

<b>G 150 / 1</b>	8 kg
<b>G 150 / 2</b>	12 kg
<b>G 150 / 3</b>	16 kg

Max pressione uscita **200 Atm**

Art. **G 150 B** Pompa a barile per olio



### Completa di

Tubo PVC mt. 1,5  
Beccuccio in acciaio

Art.	Capacità
------	----------

<b>G 150 B / 0</b>	8 Lt
<b>G 150 B / 1</b>	12 Lt
<b>G 150 B / 2</b>	16 Lt





## AEROPULSOMETRO PER GRASSO



### Aeropulsometro per fusti da

	KG 25	KG 50	KG 200
<b>Dati tecnici</b>			
Rapp.compressione	40 : 1	40 : 1	40 : 1
Press.esercizio bar	4 - 8	4 - 8	4 - 8
Erogaz. s /tubo Kg/min	0,700	0,700	0,700
Lung. pompante mm	450	750	950

#### Kit completo di

Tubo a.p. Mt. 3  
Coperchio  
Pistola per grasso  
Carrello  
Premigrasso

Art	Per fusti
<b>KIT 20</b>	25 Kg
<b>KIT 50</b>	50 Kg
<b>KIT 200</b>	200 Kg

Dati , descrizioni , illustrazioni riportati nel seguente catalogo , non sono impegnativi e nessuna responsabilità potrà derivare alla DE PALMA TRADE per effetto di loro modifiche, sostituzioni o migliorie che potranno essere effettuate anche senza preavviso .

Art. **G 330**

### Pistola distribuzione grasso



Completa di Tubo a.p. gomma  
Testina a quattro griffe



## AVVOLGITUBO AUTOMATICO



**GRASSO** Art. **G 259 / 15**

Avvolgitubo completo di tubo da 15 Mt ( 1/4 ) per grasso

**OLIO** Art. **G 260 / 15**

Avvolgitubo completo di tubo da 15 Mt ( 1/2 ) per olio

### SU RICHIESTA

Staffa girevole per avvolgitubi

Lunghezze maggiori

Tubi alta portata



**ATTENZIONE : NON UTILIZZARE CON LIQUIDI CORROSIVI , INFIAMMABILI O NOCIVI PER INALAZIONE**

**CAR 1**

**CAR 2**

**CARRELLI PER FUSTI DA 200 KG**

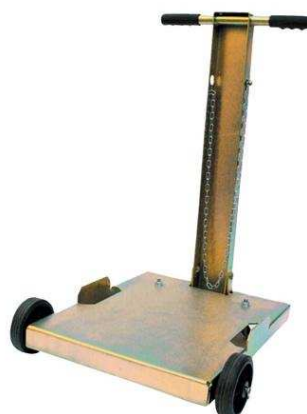

## PISTOLE TRAVASO

Art. **G 265**

Pistola in alluminio travaso olio e gasolio funzionante anche per gravità



Attacco girevole F 1" G  
Erogazione max lt / min. 60

---

Pistola erogazione gasolio con interruzione automatica del flusso

Art. **G 265 / 1** Erog.max lt / min. 60

Art. **G 265 / 2** Erog.max lt / min. 80

Art. **G 265 / 3** Erog.max lt / min. 120



Art. **G 265 / V** Per benzina verde Erogazione max lt / min. 40

---

Art. **G 265 / P**

Pistola in plastica travaso olio - gasolio - urea / ad-blue



Attacco a resca mm 25  
Erogazione max lt / min. 60



# TUBI IN GOMMA PER GASOLIO

## con raccordi

PRESSIONE MASSIMA : 10 Bar

ADATTO PER : GASOLIO / OLIO / UREA

Art	TUBO	LUNGHEZZA	RACCORDI maschio
-----	------	-----------	---------------------

1912	19 x 26	2,5 Mt	3/4" - 3/4"
1922	19 x 26	2,5 Mt	3/4" - 1"
1932	19 x 26	2,5 Mt	1" - 1"

1914	19 x 26	4 Mt	3/4" - 3/4"
1924	19 x 26	4 Mt	3/4" - 1"
1934	19 x 26	4 Mt	1" - 1"

1916	19 x 26	6 Mt	3/4" - 3/4"
1926	19 x 26	6 Mt	3/4" - 1"
1936	19 x 26	6 Mt	1" - 1"

Art	TUBO	LUNGHEZZA	RACCORDI maschio
-----	------	-----------	---------------------

2612	25 x 35	2,5 Mt	3/4" - 3/4"
2622	25 x 35	2,5 Mt	3/4" - 1"
2632	25 x 35	2,5 Mt	1" - 1"

2614	25 x 35	4 Mt	3/4" - 3/4"
2624	25 x 35	4 Mt	3/4" - 1"
2634	25 x 35	4 Mt	1" - 1"

2616	25 x 35	6 Mt	3/4" - 3/4"
2626	25 x 35	6 Mt	3/4" - 1"
2636	25 x 35	6 Mt	1" - 1"



### FILTRO A CARTUCCIA

#### PER GASOLIO

PRESSIONE MASSIMA : 12 Bar

ATTACCHI FEMMINA 1"

PORTATA MASSIMA 100 Lt / Min.



Art  
**GASOLIO**

### FILTRO A CARTUCCIA

#### SEPARATORE ACQUA / GASOLIO

PRESSIONE MASSIMA : 3,5 Bar

ATTACCHI FEMMINA 1"

PORTATA MASSIMA 100 Lt / Min.



Art  
**ACQUA**





## POMPE ELETTRICHE PER TRAVASO GASOLIO

Art. **G 270/220** Stazione murale elettrica autoadescante travaso gasolio **220 Volt**



**Completa di :**

valvola by pass  
Pannello per esterni  
Contaltri meccanico  
Tubo mandata + aspirazione  
Pistola alluminio  
Filtro

**Erogazione It / min. 50**

**SU RICHIESTA**

**Erogazione It / min. 70**

**Erogazione It / min. 100**

---

Art. **G 272 / 12** Pompa elettrica portatile per travaso gasolio **12 Volt**

Art. **G 272 / 24** Pompa elettrica portatile per travaso gasolio **24 Volt**



**Completa di :**

Elettropompa  
Filtro  
Cavo con pinze  
Tubo mandata + aspirazione  
Pistola

**Erogazione It / min. 40**

**SU RICHIESTA**

**Erogazione It / min. 80**



## DISTRIBUTORE GASOLIO

Art. **G 273**

Postazione distribuzione gasolio , con basamento -- Volt 220



### Completa di :

- Elettropompa Volt 220
- 4 antivibranti supporto pompa
- Pistola automatica 60 Lt / min
- Struttura in lamiera verniciata per esterni
- Contaltri meccanico
- Leva di marcia / arresto
- Tube Lung. 4 mt - da 3/4
- Dimensioni 400 x 1300 x 290 profondità

Erogazione It / min. 56

---

## CONTALITRI MECCANICI E ELETTRONICI PER GASOLIO/OLIO

Art. **G 274 / 1**

Contaltri meccanico 3 cifre

Art. **G 274 / 2**

Contaltri meccanico 4 cifre

**Portata**  
20 / 120 Lt / Min

**Attacchi**  
1 "

**Pressione**  
Max 3,5 bar

Art. **G 274 / D**

Contaltri digitale



**E' VIETATO L'UTILIZZO CONTO TERZI , ARTICOLI DESTINATI SOLO PER USO PRIVATO**



## PRODOTTI PER FLUIDO UREA - ADBLUE

Art. **G 227**



**Pompa** manuale rotativa  
in materiale plastico  
per fusti da 200 kg

Art. **G 265 / P**

**Pistola** erogatrice in polipropilene  
olio - gasolio - urea / ad-blue



Art. **G 275 / 220**

**Stazione murale per travaso - 220 Volt**

**Completa di :**

Elettropompa acciaio inox  
Contenitore in metallo per esterni  
Contaltri meccanico  
Tubo mandata + aspirazione  
Pistola polipropilene

**Erogazione It / min. 30**



Art. **G 275 / 12**

**Pompa travaso** elettrica portatile 12 Volt  
per urea / ad - blue

Art. **G 275 / 24**

**Pompa elettrica portatile 24 Volt**  
per urea / ad - blue

**Completa di :**

Elettropompa  
Filtro  
Cavo con pinze  
Tubo mandata + aspirazione  
Pistola propilene

**Erogazione It / min. 40**



## RECUPERATORE / ASPIRATORE OLIO

Art. **G 282/ 80**



Recuperatore aspiratore olio completo di :

- Indicatore di livello
- Kit completo di sonde
- Svuotamento pneumatico serbatoio
- Precamera da 8 lt
- Coppa di recupero con griglia scola filtro

Serbatoio lt 80

## BASI DI RACCOLTA OLIO PER FUSTI DA 200 Kg

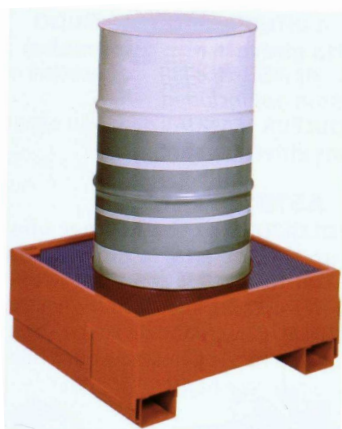

**BASE 1**



**BASE 2**



# NEBULIZZATORI

Art. **G 284**



Nebulizzatore in acciaio per la nebulizzazione atossica di liquidi detergenti , oli lubrificanti ed affini , a bassa tensione .  
Con i nebulizzatori d'acciaio è possibile utilizzare liquidi a base di solventi alcalini che non contengono basi acide .

Art. **G 284 / 24** Serbatoio lt 24

Art. **G 284 / 50** Serbatoio lt 50

Completo di : Tubo spiralato mt 5 / Lancia in pvc  
Valvola di sicurezza / Indicatore livello

Art. **G 287**



Nebulizzatori in acciaio **INOX** per la nebulizzazione atossica

Art. **G 287 / 24** Serbatoio lt 24

Art. **G 287 / 50** Serbatoio lt 50

Completo di : Tubo spiralato mt 5 / Lancia in acciaio inox  
Valvola di sicurezza / Indicatore livello



**ATTENZIONE : NON UTILIZZARE CON LIQUIDI CORROSIVI , INFIAMMABILI O NOCIVI PER INALAZIONE**





## ACCESSORI PER DISTRIBUZIONE OLIO / GRASSO

Art. **G 335 / 1**

Pistola distribuzione **olio** con estremità rigida e valvola anti goccia



Attacco F 1/2 G "

Art. **G 335 / 2**

Pistola distribuzione **olio** completa di contaltri elettronico .  
Dotata di totalizzatore e parziale azzerabile .



Attacco F 1/2 G "

**TUBO ALTA PRESSIONE** per aeropulsometri **OLIO** - TIPO R 1 - c/raccordi FF 1/2

**OLIO / 3**

3 mt

**OLIO / 5**

5 mt

**OLIO / 10**

10 mt

**OLIO / 15**

15 mt

**TUBO ALTA PRESSIONE** per aeropulsometri **GRASSO** - TIPO R 2 - c/raccordi 1/4 - 3/8

**GRASSO / 3**

500 bar

3 mt

**GRASSO / 4**

500 bar

4 mt

**GRASSO / 5**

500 bar

5 mt

**GRASSO / 6**

500 bar

6 mt



## OLIATORI A PRESSIONE

Art. **G 112**

Oliatore a pressione corpo in lamiera ,cannuccia flessibile



Art.	Contenuto
<b>G 112 / 1</b>	200 cc
<b>G 112 / 2</b>	300 cc
<b>G 112 / 3</b>	500 cc
<b>G 112 / 4</b>	750 cc
<b>G 112 / 5</b>	1000 cc

Art. **G 112 / B**

Oliatore a pressione corpo in polietilene ,pompa in materiale plastico e cannuccia flessibile .



Art.	Contenuto
<b>G 112 / B 1</b>	200 cc
<b>G 112 / B 2</b>	300 cc
<b>G 112 / B 3</b>	500 cc
<b>G 112 / B 4</b>	700 cc

Art. **G 112 / R FLEX**

Canna ricambio flessibile per oliatori art D 112



## POMPE TRAVASO OLIO / GASOLIO / UREA



Pompa travaso olio - gasolio a **movimento alternato**  
Autoadescante - Corpo Alluminio

Art. **G 220**

Erogazione It / min. 15

Art. **G 221**

Erogazione It / min. 30



Art. **G 222**

Pompa travaso olio - gasolio  
a **movimento rotatorio**  
Autoadescante - Corpo in fusione di Zama



Art. **G 227**

Pompa rotativa in **materiale plastico**  
per travaso olio - gasolio - urea / ad-blue



## SPIE LIVELLO OLIO

Art. **G 723**

Spie livello olio in alluminio .**FINESTRA IN VETRO** indicatore a forma stellare bianca e guarnizione di tenuta in fibra .

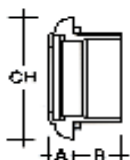

Art	Filetto	A	B	Ch
G 723 / 1	G 1/2	6	9	27
G 723 / 2	G 3/4	7	10	32
G 723 / 3	G 1 "	8,5	14	41
G 723 / 4	G 1 1/4	8,5	14	50
G 723 / 5	G 1 1/2	8,5	14	55

Temperatura max. vetro 130 °C. Pressione esercizi o max 10 bar

Art. **G 724**

Spie livello in **RESINA** poliammidica resistente ad agenti chimici , oli , benzine e solventi vari .

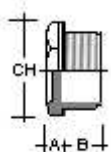

Art	Filetto	A	B	Ch
G 724 / 1	G 1/4	7	8	17
G 724 / 2	G 3/8	6,5	10,5	18
G 724 / 3	G 1/2	8	11	24
G 724 / 4	G 3/4	8	12	30
G 724 / 5	G 1 "	11	12	35
G 724 / 6	G 1 1/4	10	16	42
G 724 / 7	G 2 "	12	22	64

Temperatura max. 100 °C. - Pressione max. 3,5 bar - Guarnizione di tenuta in fibra



## LIVELLI OLIO

Art. **G 733**

Livello olio verticale in **resina** poliammidica resistente agli agenti chimici , oli , benzine e solventi vari - Indicati per l'installazione su serbatoi o centraline di fluidi idraulici .



Art.	h Tot. mm	Distanza fori fissaggio	Viti fissag.
------	-----------	-------------------------	--------------

G 733 / 1	110	76 mm	M 10
G 733 / 2	165	127 mm	M 12
G 733 / 3	250	210 mm	M 12

Temperatura max 100 °C. Tenuta mediante guarnizion e piana in gomma e OR

## TAPPI SFIATO

Art. **G 754**

Tappo di sfiato con valvola in ottone e cappuccio in acciaio  
Filetto cilindrico



Art	Filetto	A	C	Ch
G 754 / 1	G 3/8	19	9	20
G 754 / 2	G 1/2	19	10	24
G 754 / 3	G 3/4	23	12	32
G 754 / 4	G 1	30	13	40

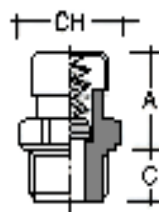

La sovrappressione viene liberata dalla apertura della molla pretarata ad una pressione di 0,15 / 0,35 bar lasciando uscire i vapori per poi richiudersi .





## TRAVASATORI E IMBUTI

Art. **G 216 / B**

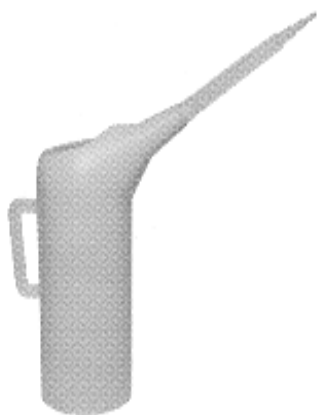

Recipiente graduato in **polietilene**  
con prolunga flessibile

Art. Litri

<b>G 216 / B2</b>	2
<b>G 216 / B5</b>	5

Art. **G 218**



Imbuto in **polietilene**  
con filtro e prolunga flessibile

∅ mm

200

Art. **G 219**

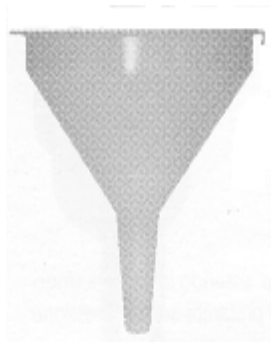

Imbuto , con filtro , in **polietilene**

Art. ∅ mm

<b>G 219 / 20</b>	200
<b>G 219 / 25</b>	250
<b>G 219 / 30</b>	300



## TANICHE PER CARBURANTI

Art. **G 400**

Tanica in metallo omologata per trasporto carburanti



Art.	Litri
G 400 / 5	5
G 400 / 10	10
G 400 / 20	20

Art. **G 402**

Bocchettone rigido per taniche in metallo



Art. **G 405**

Tanica in plastica omologata per trasporto carburanti

Taniche in polietilene alta densità rinforzato , dotate di travasatore flessibile avvitabile .

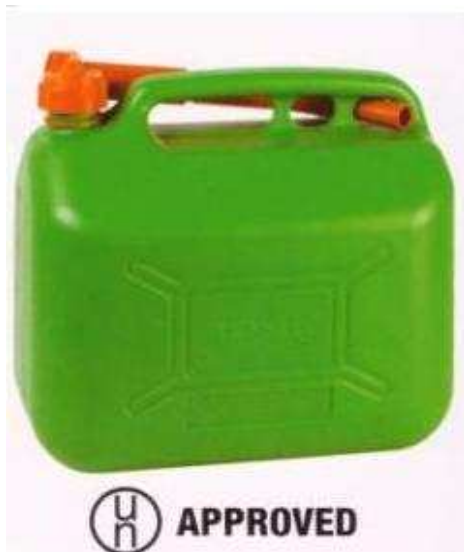

OMOLOGAZIONE DIRETTIVA CEE

Art.	Litri
G 405 / 3	3
G 405 / 5	5
G 405 / 10	10



# PNEUMATICA

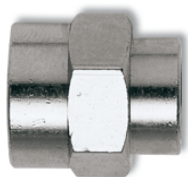

**DE PALMA TRADE SRL**

080 532 71 98 // 080 532 77 24

[WWW.DEPALMATRADE.IT](http://WWW.DEPALMATRADE.IT) - [INFO@DEPALMATRADE.IT](mailto:INFO@DEPALMATRADE.IT)

# RACCORDI PER ATTACCHI A BAIONETTA

Materiale : Ottone nichelato

Art. **A 161**

Dado fresato



Attacco F

1/4

3/8

14 x 1,25

Art. **A 162**

Raccordo maschio c/dado fresato

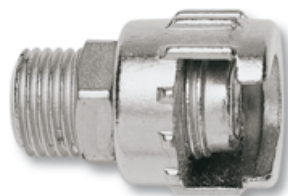

Attacco M

1/4

3/8

Art. **A 170**

Raccordo femmina con dado fresato



Attacco F

1/4

3/8

Art. **A 171**

Raccordo di giunzione con due dadi fresati

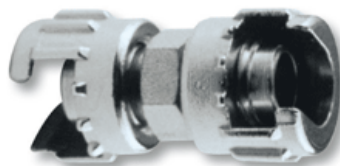

1/4

Art. **A 172**

Raccordo a " T " con tre dadi fresati

1/4

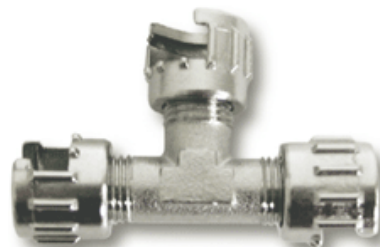

# RACCORDI PER TUBO GOMMA

Materiale : Ottone nichelato

Art. **A 163**

Attacco portagomma a baionetta

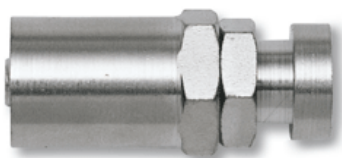

**Tubo**

6 x 14

8 x 17

10 x 19

Art. **A 164**

Innesto rapido portagomma



**Tubo**

6 x 14

8 x 17

10 x 19

Art. **A 173**

Attacco portagomma maschio



**Attacco M Tubo**

1/4 6 x 14

1/4 8 x 17

3/8 6 x 14

3/8 8 x 17





## RUBINETTI RAPIDI e INNESTI

**Materiali** : Ottone nichelato / Molla in acciaio / OR in NBR / Pressione max 0 - 16 Bar

**Fluidi compatibili** : aria compressa

Art. **A 166**

**Rubinetto rapido maschio**

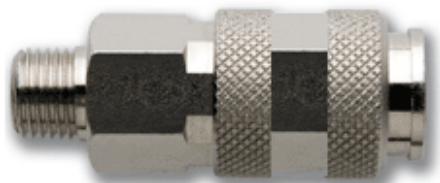

Attacco Maschio

1/4
3/8
1/2

Art. **A 167**

**Rubinetto rapido femmina**



Attacco Femmina

1/4
3/8

Art. **A 168**

**Rubinetto rapido con portagomma**



**Tubo**

6 x 14
8 x 17
10 x 19

Art. **A 165**

**Innesto rapido a baionetta**

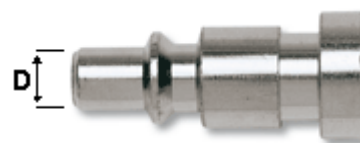

**D**

**profilo**

7,4	italiano
9,9	tedesco

Art. **A 169**

**Innesto rapido maschio**



Attacco Maschio	D	profilo
1/4	7,4	italiano
3/8	7,4	italiano
1/2	7,4	italiano
1/4	9,9	tedesco
3/8	9,9	tedesco
1/2	9,9	tedesco

Art. **A 177**

**Innesto rapido femmina**



Attacco Maschio	D	profilo
1/4	7,4	italiano
3/8	7,4	italiano
1/4	9,9	tedesco
3/8	9,9	tedesco



# INNESTI E RUBINETTI SERIE GIGANTE

Pressione max : 0 - 20 bar

Art. **A 164 G**

Innesto rapido portagomma



Tubo	L	Ch
10 x 19	68	22
13 x 23	71	22

Art. **A 166 G**

Rubinetto rapido maschio

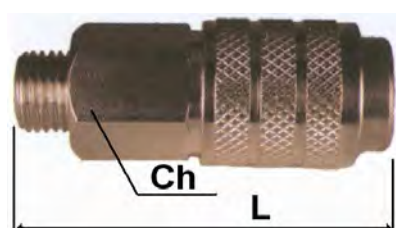

Maschio	L	Ch
3/8	62	24
1/2	64	24
3/4	68	27

Art. **A 168 G**

Rubinetto rapido per tubo gomma

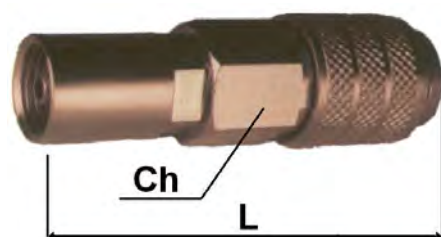

Tubo	L	Ch
10 x 19	85	24
13 x 23	92	24

Art. **A 169 G**

Innesto rapido maschio

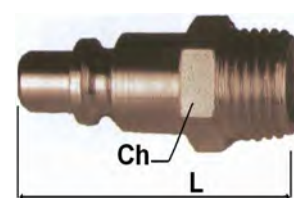

Maschio	L	Ch
3/8	39	17
1/2	43	22
3/4	48	27

Art. **A 167 G**

Rubinetto rapido femmina

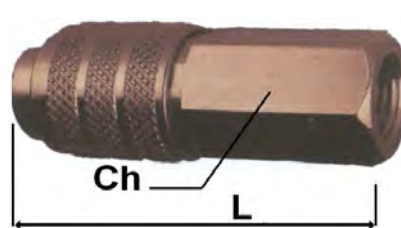

Femmina	L	Ch
3/8	58	24
1/2	65	27

Art. **A 177 G**

Innesto rapido femmina

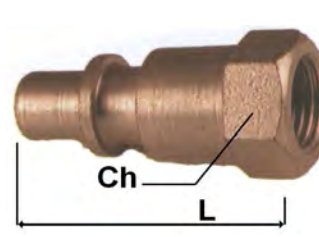

Femmina	L	Ch
3/8	39	22
1/2	42	27

T  
I  
P  
O  
  
G  
I  
G  
A  
N  
T  
E



# RACCORDERIA

Materiale : ottone nichelato

Applicazioni : pneumatica , idraulica , oleodinamica

Art. **A 178**

**Tappo cilindrico**

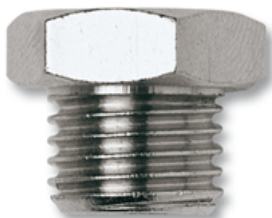

Attacco  
*maschio* chiave

1/8	12
1/4	14
3/8	19
1/2	24
3/4	30

Art. **A 179**

**Nipplo conico**



Attacco M - M

1/8 x 1/8	1/4 x 1/2
1/8 x 1/4	3/8 x 3/8
1/8 x 3/8	3/8 x 1/2
1/4 x 1/4	1/2 x 1/2
1/4 x 3/8	1/2 x 3/4

Art. **A 180**

**Riduzione conica**

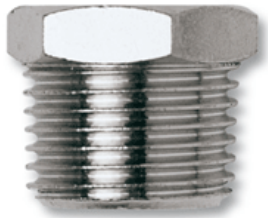

Attacco M - F

1/8 - 1/8	3/8 - 1/4
1/8 - 1/4	3/8 - 3/8
1/8 - 3/8	3/8 - 1/2
1/8 - 1/2	1/2 - 1/4
1/4 - 1/4	1/2 - 3/8
1/4 - 3/8	1/2 - 1/2
1/4 - 1/2	3/4 - 3/8
	3/4 - 1/2
	1" - 1/2

Art. **A 181**

**Manicotto di riduzione**

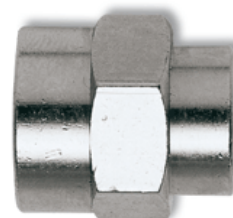

Attacco F - F

1/8 x 1/4	3/8 x 1/2
1/8 x 3/8	1/2 x 3/4
1/4 x 3/8	1/2 x 1/2
1/4 x 1/2	1/2 x 1"



# RACCORDERIA

Materiale : ottone nichelato

Applicazioni : pneumatica , idraulica , oleodinamica

Art. **A 182**

Deviazione F - F - F



1/4
3/8
1/2

Art. **A 183**

Deviazione F - F - M

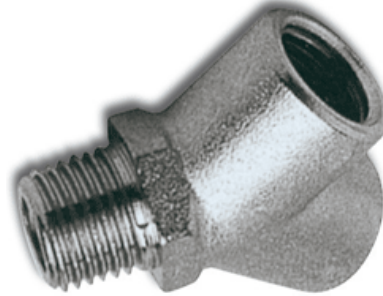

1/4
3/8
1/2

Art. **A 184**

Raccordo a L maschio

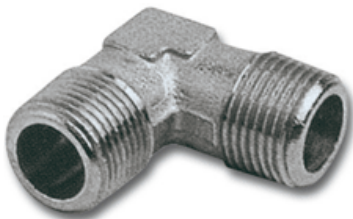

1/8
1/4
3/8
1/2
3/4
1 "

Art. **A 185**

Raccordo a L M - F

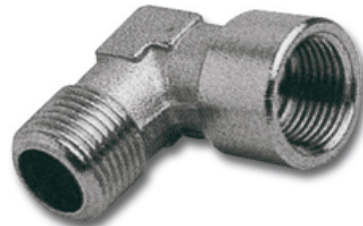

1/8
1/4
3/8
1/2
3/4
1 "

Art. **A 186**

Raccordo a L femmina



1/8
1/4
3/8
1/2
3/4
1 "



# RACCORDERIA

Materiale : ottone nichelato

Applicazioni : pneumatica , idraulica , oleodinamica

Art. **A 187**

Raccordo a T maschio centrale



**Attacco M - F - F**

1/8
1/4
3/8
1/2
3/4
1 "

Art. **A 189**

Raccordo a T femmina



**Attacco F - F - F**

1/8
1/4
3/8
1/2
3/4
1 "

Art. **A 191**

Raccordo a croce M-F



**Attacco M - F - F - F**

1/8
1/4
3/8
1/2

Art. **A 192**

Raccordo a croce F



**Attacco F - F - F - F**

1/8
1/4
3/8
1/2



# RACCORDI PER TUBI PLASTICI

Materiale : ottone nichelato

Pressione max 16 bar

Art. **A 193**

Attacco a baionetta



**Tubo**

4 x 6
6 x 8
6,5 x 10
8 x 10
8 x 12
10 x 12

Art. **A 196**

Raccordo maschio girevole



**Maschio | Tubo**

1/4	4 x 6
1/4	5 x 8
1/4	6 x 8
1/4	6,5 x 10
1/4	8 x 10
1/4	8 x 12
1/4	10 x 12





# RACCORDI PER TUBI PLASTICI

Materiale : ottone nichelato

Pressione max 16 bar

Art. **A 198**

**Innesto rapido**



**Tubo**

4 x 6

6 x 8

8 x 10

8 x 12

10 x 12

Art. **A 199**

**Rubinetto rapido standard**

**Tubo**

4 x 6

6 x 8

8 x 10

10 x 12



# RUBINETTI

Materiale : ottone nichelato

O-Ring : NBR

Pressione max : 12 bar

Temperatura di lavoro  
- 10 °C // + 80 °C

Art. **A 231**

Rubinetto di scarico



Attacco Maschio

1/4

3/8

Art. **A 232**

Rubinetto di linea c/dado fresato e volantino



Attacco Maschio

1/4

3/8

1/2

Art. **A 236**

Rubinetto di linea c/dado fresato

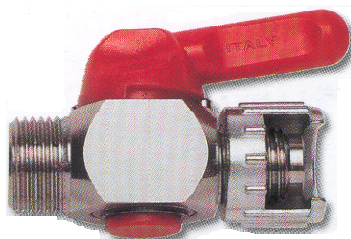

Attacco Maschio

1/4

3/8

1/2

Art. **A 239**

Rubinetto corsoio con ghiera



Attacco Maschio

1/4

3/8

1/2



# RACCORDI AUTOMATICI PER TUBI PLASTICI

Nylon - Rilsan - Poliuretano

Materiale : ottone nichelato

Pinza : acciaio inox

Pressione : max 15 bar

APPLICAZIONI : circuiti pneumatici

Art. **A 671**

Raccordo diritto maschio conico



Codice	Tubo	Maschio
67101	4 x 6	1/8
67102	6 x 8	1/8
67103	4 x 6	1/4
67104	6 x 8	1/4
67105	8 x 10	1/4
67106	6 x 8	3/8
67107	8 x 10	3/8
67108	10 x 12	3/8

Art. **A 672**

Raccordo diritto intermedio



Codice	Tubo
67201	2 x 4
67202	4 x 6
67203	6 x 8
67204	8 x 10
67205	10 x 12
67206	12 x 14
67207	14 x 16

Art. **A 673**

Raccordo a L maschio conico



Codice	Tubo	Maschio
67301	4 x 6	1/8
67302	6 x 8	1/8
67303	4 x 6	1/4
67304	6 x 8	1/4
67305	8 x 10	1/4
67306	8 x 10	3/8
67307	10 x 12	3/8

Art. **A 674**

Raccordo a L intermedio



Codice	Tubo
67401	2 x 4
67402	4 x 6
67403	6 x 8
67404	8 x 10
67405	10 x 12



# RACCORDI AUTOMATICI PER TUBI PLASTICI

Nylon - Rilsan - Poliuretano

Materiale : ottone nichelato

Pinza : acciaio inox

Pressione : max 15 bar

APPLICAZIONI : circuiti pneumatici

Art. **A 675**

Raccordo a T maschio conico



Codice	Tubo	Maschio
67501	4 x 6	1/8
67502	6 x 8	1/8
67503	6 x 8	1/4
67504	8 x 10	1/4
67506	8 x 10	3/8
67507	10 x 12	3/8

Art. **A 676**

Raccordo a T intermedio



Codice	Tubo
67601	2 x 4
67602	4 x 6
67603	6 x 8
67604	8 x 10
67605	10 x 12

Art. **A 677**

Raccordo a L girevole maschio conico



Codice	Tubo	Maschio
67701	4 x 6	1/8
67702	6 x 8	1/8
67703	4 x 6	1/4
67704	6 x 8	1/4
67705	8 x 10	1/4
67706	8 x 10	3/8
67707	10 x 12	3/8



# TUBI IN MATERIALE PLASTICO PASSAGGIO ARIA

matasse da 100 mt

Art. **RILSAN**

**Tubo lineare RILSAN PA 12**

Tubo	PRESSIONE bar		Raggio Curvatura m/m
	Utilizzo	Scoppio	
2 x 4	44	130	15
4 x 6	27	81	30
6 x 8	20	60	40
8 x 10	15	45	60
10 x 12	12	36	85
12 x 14	11	33	90

Temperatura di lavoro - 20 °C // + 80 °C

Notevole resistenza agli idrocarburi / olii

Buona inerzia agli agenti chimici

Notevole flessibilità

Elevate proprietà meccaniche

Colore : neutro

Art. **NYLON**

**Tubo lineare NYLON 6**

Tubo	PRESSIONE bar		Raggio Curvatura m/m
	Utilizzo	Scoppio	
2 x 4	55	165	25
4 x 6	27	81	60
6 x 8	20	60	100
8 x 10	15	45	150
10 x 12	13	39	200

Temperatura di lavoro - 10 °C // + 80 °C

Notevole resistenza agli idrocarburi / olii

Buona inerzia agli agenti chimici

Limitata flessibilità

Colore : neutro

Art. **POLIURETANO**

**Tubo lineare POLIURETANO 98 Sh A**

Tubo	PRESSIONE bar		Raggio Curvatura m/m
	Utilizzo	Scoppio	
4 x 6	10	40	18
5,5 x 8	10	40	30
6 x 8	7	28	35
7,5 x 10	7,5	30	40
8 x 10	5,5	22	45
9 x 12	6	25	50
11 x 14	5	22	150
12 x 14	3	12	150

Temperatura di lavoro - 20 °C // + 80 °C

Altissima flessibilità alle basse temperature

Buona resistenza agli agenti atmosferici

Estremamente resistente alla fatica

Colore : Azzurro

PER INFORMAZIONI SULLE CARATTERISTICHE TECNICHE : 080 532 71 98 - [info@depalmatrade.it](mailto:info@depalmatrade.it)



# TUBI GOMMA PASSAGGIO ARIA

matasse da 100 mt

Art. **TAR**

Tubo	PRESSIONE bar	
	Utilizzo	Scoppio

	6 x 14	20	60
	8 x 17	20	60
3/8	10 x 19	20	60
1/2	13 x 23	20	60
3/4	19 x 30	20	60
1 "	25 x 37	20	60

**Tube Gomma con rinforzo tessile**

Temperatura di lavoro - 30 °C // + 70 °C

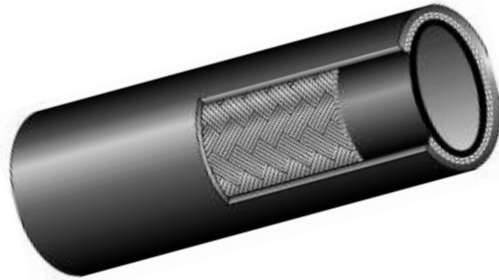

# ROCCHETTO IN CARTONE AUTOPORTANTE

Art. **ROCCHETTO**

Diametro esterno 400 mm



PER INFORMAZIONI SULLE CARATTERISTICHE TECNICHE : 080 532 71 98 - [info@depalmatrade.it](mailto:info@depalmatrade.it)





## TUBI A SPIRALE PASSAGGIO ARIA

Art. **A 130**

**Tubo RILSAN PA 12**

Codice	Tubo	MT	Pressione scoppio
A 1	4 x 6	7,5	<b>81 bar</b>
A 2	4 x 6	15	
A 3	4 x 6	30	
B 1	6 x 8	7,5	<b>60 bar</b>
B 2	6 x 8	15	
B 3	6 x 8	30	
C 1	8 x 10	7,5	<b>45 bar</b>
C 2	8 x 10	15	
C 3	8 x 10	30	
D 1	10 x 12	7,5	<b>39 bar</b>
D 2	10 x 12	15	
D 3	10 x 12	30	

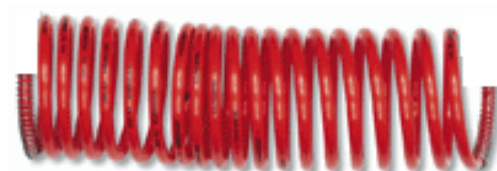

Art. **A 135**

**Tubo POLIURETANO 98ShA c/raccordi**

Codice	Tubo	MT	Raccordo Maschio	Pressione scoppio
A 1	5 x 8	5	1/4	<b>52 bar</b>
A 1	5 x 8	10	1/4	
A 2	5 x 8	15	1/4	
B 1	6,5 x 10	10	1/4	<b>40 bar</b>
B 2	6,5 x 10	15	1/4	
C 1	8 x 12	5	3/8	<b>28 bar</b>
C 2	8 x 12	10	3/8	
C 3	8 x 12	15	3/8	



Art. **A 140**

**KIT per autocarro**



Spirale in poliuretano 98 ShA da mt 4

Raccordi

Pistola nylon



## PISTOLE SOFFIAGGIO ARIA

Art. **A 153**

Materiale : **ALLUMINIO**



Art. **A 154**

Materiale : **ALLUMINIO**

Canna lunga

Art. **A 153 / N**

Materiale : **NYLON**



## PISTOLE LAVAGGIO e VERNICIATURA

Art. **A 155 / C** Pistola lavaggio con serbatoio in acciaio verniciato capacità lt. 1



Canna corta

Art. **A 158**

Aerografo per verniciatura con serbatoio inferiore

Codice	Ugello	serbatoio
B 1	1,5 mm	1 LT
B 2	1,8 mm	1 LT
B 3	2,0 mm	1 LT
B 4	2,5 mm	1 LT



## PISTOLE GONFIAGOMME

Art. **A 213**

**Pistola gonfiaggio con manometro**

sistema di scarico con bottone laterale



Art. **A 214**

**Pistola gonfiaggio professionale , con manometro**

sistema di scarico con leggera pressione della leva



Art. **A 215**

**Testina gonfiaggio**

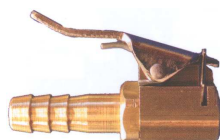

Attacco porta gomma : mm 7



# FILTRI e LUBRIFICATORI D'ARIA

## Filtro depuratore d'aria

Filtraggio : 10 Micron  
Press.Max in entrata : 14 Bar  
Portata : 6000 Lt/min. 6 Bar

Scarico condensa rapido

Art. **A 750**

Entrata / Uscita

1/2

Su richiesta : 1/4 - 3/8 - 1 "



## Lubrificatore d'aria a nebbia d'olio

Press.Max in entrata : 14 Bar  
Portata : 6000 Lt/min. 6 Bar

Art. **A 751**

Entrata / Uscita

1/2

Su richiesta : 1/4 - 3/8 - 1 "



## RIDUTTORE DI PRESSIONE

a pistone c / manometro

Manopola di regolazione c/blocco  
Pressione max.in entrata 14 Bar  
Campo di regolazione da 0 a 12 Bar  
Portata 6000 Lt/min. 6 Bar

Art. **A 755**

Entrata / Uscita

1/2

Su richiesta : 1/4 - 3/8 - 1 "



## GRUPPO : Filtro / Riduttore / lubrificatore

con manometro

Portata : 5000 Lt

Art. **A 758**

Entrata / Uscita

1/2

Su richiesta : 1/4 - 3/8 - 1 "



## RIDUTTORI - FILTRI - MANOMETRI

### Riduttore di pressione c / manometro da 40 e rubinetto rapido universale

Pressione max . 12 Bar  
Portata 1700 Lt/min 6 Bar

Art. **A 760**

Entrata

1/4



### Riduttore di pressione c/ filtro-manometro da 40 e 2 rubinetti rapidi universali

Pressione max . 12 Bar  
Portata 1800 Lt/min 6 Bar

Art. **A 761**

Entrata

3/8



Art. **A 765**

#### Manometri

Codice	∅	Scala	Attacco
765 / 1	63	0 - 12	RADIALE
765 / 2	40	0 - 12	POST.
765 / 3	50	0 - 12	POST.
765 / 4	63	0 - 12	POST.
765 / 5	80	0 - 12	POST.





## MANOMETRI IN GLICERINA

Art. **A 770**

**Manometro con attacco posteriore**



Codice	∅	Scala	Attacco
<b>770 / 1</b>	63 mm	0 - 16	1/4
<b>770 / 2</b>	63 mm	0 - 25	1/4
<b>770 / 3</b>	63 mm	0 - 40	1/4
<b>770 / 4</b>	63 mm	0 - 60	1/4
<b>770 / 5</b>	63 mm	0 - 100	1/4
<b>770 / 6</b>	63 mm	0 - 160	1/4
<b>770 / 7</b>	63 mm	0 - 250	1/4

Art. **A 771**

**Manometro con attacco radiale**



Codice	∅	Scala	Attacco
<b>771 / 1</b>	63 mm	0 - 16	1/4
<b>771 / 2</b>	63 mm	0 - 25	1/4
<b>771 / 3</b>	63 mm	0 - 40	1/4
<b>771 / 4</b>	63 mm	0 - 60	1/4
<b>771 / 5</b>	63 mm	0 - 100	1/4
<b>771 / 6</b>	63 mm	0 - 160	1/4
<b>771 / 7</b>	63 mm	0 - 250	1/4





serbatoi portatili



avvolgitubo per aria compressa



accessori per

verniciare  
sabbare  
lavare

detergenti  
sgrassanti  
disincrostanti  
cere  
shampoo  
disinfettanti  
disinfestanti



# ARTICOLI TECNICI

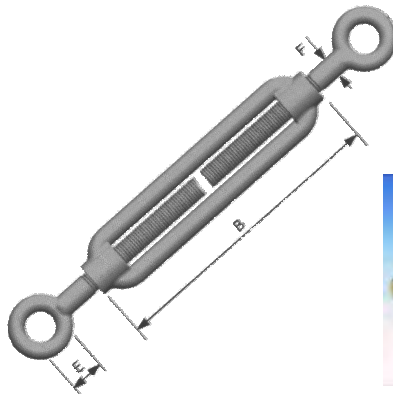
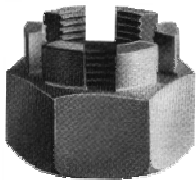
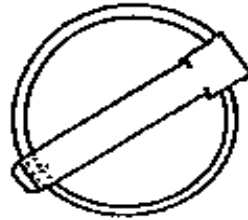
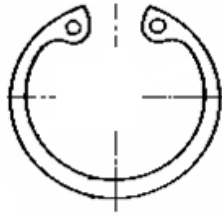

## ADDITIVO PER MOTORI DIESEL

### MULSIREX

MULSIREX è un fluido esplicitamente studiato per motori diesel normali e common rail , raccomandato anche per motori marini .

Le caratteristiche disperdenti e emulsionanti riducono i residui carboniosi e le particelle d'acqua presenti nel gasolio grazie al DIPENTENE , ingrediente principale del MULSIREX , che esercita una potente azione disperdente .

MULSIREX disgrega le morchie ,residui gommosi e paraffinici , l'acqua, tutti quei prodotti dannosi per il motore presenti nel gasolio espellendoli durante la combustione .

MULSIREX è raccomandato nei periodi freddi , abbassa la temperatura di congelamento dell'acqua e di addensamento delle paraffine ( presenti nel gasolio ) ottimizzando la combustione .

Esplica anche un'ottima azione lubrificante sui componenti meccanici del motore quali la pompa d'iniezione, il turbo , le valvole ,gli iniettori , riducendone l'usura ed allungandone la vita operativa .

MULSIREX non contiene solventi clorurati,fluorurati,zolfo e suoi composti.



CONTENUTO LATTINA LT. 1

PER INFORMAZIONI TECNICHE 080 532 71 98 / 080 532 77 24

[INFO@DEPALMATRADE.IT](mailto:INFO@DEPALMATRADE.IT)





# ANELLI RADIALI UNI 7434 DIN 6799

NS. CODICE	DIAMETRO GOLA ( D )
	mm
ANRAD1,2	1,2
ANRAD1,5	1,5
ANRAD1,9	1,9
ANRAD2,3	2,3
ANRAD3,2	3,2
ANRAD004	4
ANRAD005	5
ANRAD006	6
ANRAD007	7
ANRAD008	8
ANRAD009	9
ANRAD010	10
ANRAD012	12
ANRAD015	15
ANRAD019	19
ANRAD024	24

DIMENSIONI ANELLO	
mm	
A	T
2,90	0,30
3,85	0,40
4,40	0,50
5,90	0,60
6,80	0,60
8,80	0,70
10,75	0,70
11,75	0,70
13,80	0,90
15,60	1,00
18,20	1,10
19,65	1,20
22,65	1,30
28,60	1,50
36,70	1,75
43,65	2,00

confezione

300 pz
300 pz
300 pz
200 pz
200 pz
200 pz
100 pz
100 pz
100 pz
100 pz
50 pz
50 pz
50 pz
50 pz

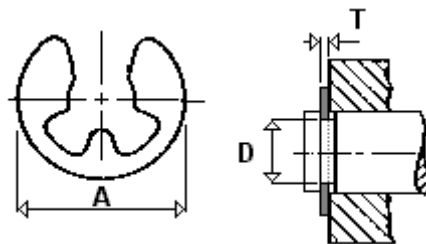

A PAG 58 E' PRESENTE L'ASSORTIMENTO IN CASSETTA





# ANELLI SEEGER ESTERNI UNI 7435 - DIN 471

MATERIALE :

Acciaio per molle - C 60 sino al diametro 27 - C 75 dal diametro 28 in poi

NS. CODICE	DIMENSIONI		confezione pz
	DIAMETRO ALBERO mm	D 1   S mm	
ANEST004	4	3,7   0,40	200
ANEST005	5	4,7   0,60	200
ANEST006	6	5,6   0,70	200
ANEST007	7	6,5   0,80	200
ANEST008	8	7,4   0,80	200
ANEST009	9	8,4   1,00	200
ANEST010	10	9,3   1,00	100
ANEST011	11	10,2   1,00	100
ANEST012	12	11,0   1,00	100
ANEST013	13	11,9   1,00	100
ANEST014	14	12,9   1,00	100
ANEST015	15	13,8   1,00	100
ANEST016	16	14,7   1,00	100
ANEST017	17	15,7   1,00	100
ANEST018	18	16,5   1,20	100
ANEST019	19	17,5   1,20	100
ANEST020	20	18,5   1,20	100
ANEST021	21	19,5   1,20	50
ANEST022	22	20,5   1,20	50
ANEST024	24	22,2   1,20	50
ANEST025	25	23,2   1,20	50
ANEST026	26	24,2   1,20	50
ANEST028	28	25,9   1,50	50
ANEST029	29	26,9   1,50	50
ANEST030	30	27,9   1,50	50
ANEST032	32	29,6   1,50	50
ANEST034	34	31,5   1,50	50
ANEST035	35	32,2   1,50	50
ANEST036	36	33,2   1,75	50
ANEST038	38	35,2   1,75	50
ANEST040	40	36,5   1,75	50
ANEST042	42	38,5   1,75	50
ANEST044	44	40,5   1,75	50
ANEST045	45	41,5   1,75	50
ANEST048	48	44,5   1,75	50
ANEST050	50	45,8   2,00	25
ANEST052	52	47,8   2,00	25
ANEST055	55	50,8   2,00	25
ANEST056	56	51,8   2,00	25
ANEST058	58	53,8   2,00	25
ANEST060	60	55,8   2,00	25
ANEST062	62	57,8   2,00	25
ANEST063	63	58,8   2,00	25
ANEST065	65	60,8   2,50	25

NS. CODICE	DIMENSIONI		confezione pz
	DIAMETRO ALBERO mm	D 1   S mm	
ANEST068	68	63,5   2,50	25
ANEST070	70	65,5   2,50	25
ANEST072	72	67,5   2,50	15
ANEST075	75	70,5   2,50	15
ANEST078	78	73,5   2,50	15
ANEST080	80	74,5   2,50	15
ANEST082	82	76,5   2,50	15
ANEST085	85	79,5   3,00	15
ANEST090	90	84,5   3,00	15
ANEST095	95	89,5   3,00	15
ANEST100	100	94,5   3,00	15
ANEST105	105	98,0   4,00	15
ANEST110	110	103,0   4,00	15
ANEST115	115	108,0   4,00	15
ANEST120	120	113,0   4,00	15
ANEST130	130	123,0   4,00	15
ANEST135	135	128,0   4,00	15
ANEST140	140	133,0   4,00	15
ANEST145	145	138,0   4,00	15
ANEST150	150	142,0   4,00	10
ANEST155	155	146,0   4,00	10
ANEST160	160	151,0   4,00	10
ANEST165	165	155,5   4,00	10
ANEST170	170	160,5   4,00	10
ANEST175	175	165,5   4,00	10
ANEST180	180	170,5   4,00	10
ANEST185	185	175,5   4,00	10
ANEST190	190	180,5   4,00	10
ANEST200	200	190,5   4,00	10

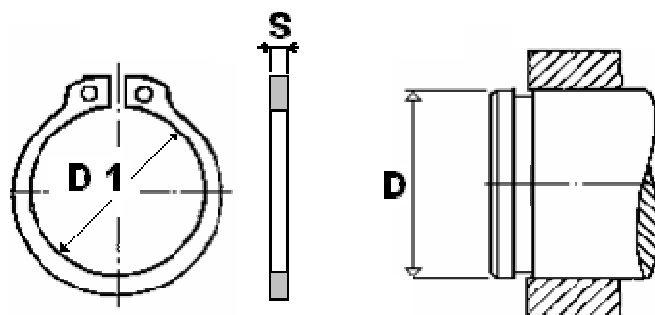

D = DIAMETRO ALBERO



# ANELLI SEEGER INTERNI UNI 7437 - DIN 472

MATERIALE :

Acciaio per molle - C 60 sino al diametro 33 - C 75 dal diametro 34 in poi

NS. CODICE	DIMENSIONI		confezione pz	NS. CODICE	DIMENSIONI		confezione pz
	DIAMETRO FORO mm	D 1   S mm			DIAMETRO FORO mm	D 1   S mm	
ANINT008	8	8,7   0,80	200	ANINT065	65	69,2   2,50	25
ANINT009	9	9,8   0,80	200	ANINT068	68	72,5   2,50	25
ANINT010	10	10,8   1,00	100	ANINT070	70	74,5   2,50	25
ANINT011	11	11,8   1,00	100	ANINT072	72	76,5   2,50	15
ANINT012	12	13,0   1,00	100	ANINT075	75	79,5   2,50	15
ANINT013	13	14,1   1,00	100	ANINT080	80	85,5   2,50	15
ANINT014	14	15,1   1,00	100	ANINT082	82	87,5   2,50	15
ANINT015	15	16,2   1,00	100	ANINT085	85	90,5   3,00	15
ANINT016	16	17,3   1,00	100	ANINT090	90	95,5   3,00	15
ANINT017	17	18,3   1,00	100	ANINT095	95	100,5   3,00	15
ANINT018	18	19,5   1,00	100	ANINT100	100	105,5   3,00	15
ANINT019	19	20,5   1,00	100	ANINT110	110	117,0   4,00	15
ANINT020	20	21,5   1,00	100	ANINT115	115	122,0   4,00	15
ANINT021	21	22,5   1,00	50	ANINT120	120	127,0   4,00	15
ANINT022	22	23,5   1,00	50	ANINT125	125	132,0   4,00	15
ANINT024	24	25,9   1,20	50	ANINT130	130	137,0   4,00	15
ANINT025	25	26,9   1,20	50	ANINT140	140	147,0   4,00	15
ANINT026	26	27,9   1,20	50	ANINT145	145	152,0   4,00	15
ANINT028	28	30,1   1,20	50	ANINT150	150	158,0   4,00	10
ANINT030	30	32,1   1,20	50	ANINT155	155	164,0   4,00	10
ANINT031	31	33,4   1,20	50	ANINT160	160	169,0   4,00	10
ANINT032	32	34,4   1,20	50	ANINT165	165	174,5   4,00	10
ANINT034	34	36,5   1,50	50	ANINT170	170	179,5   4,00	10
ANINT035	35	37,8   1,50	50	ANINT175	175	184,5   4,00	10
ANINT036	36	38,8   1,50	50	ANINT180	180	189,5   4,00	10
ANINT037	37	39,8   1,50	50	ANINT185	185	194,5   4,00	10
ANINT038	38	40,8   1,50	50	ANINT190	190	199,5   4,00	10
ANINT040	40	43,5   1,75	50	ANINT195	195	204,5   4,00	10
ANINT042	42	45,5   1,75	50	ANINT200	200	209,5   4,00	10
ANINT045	45	48,5   1,75	50				
ANINT047	47	50,5   1,75	50				
ANINT048	48	51,5   1,75	50				
ANINT050	50	54,2   2,00	25				
ANINT052	52	56,2   2,00	25				
ANINT055	55	59,2   2,00	25				
ANINT056	56	60,2   2,00	25				
ANINT058	58	62,2   2,00	25				
ANINT060	60	64,2   2,00	25				
ANINT062	62	66,2   2,00	25				

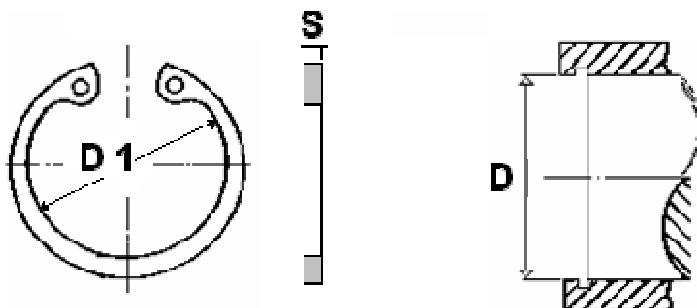

D = DIAMETRO FORO



# ASSORTIMENTI

## ANELLI RADIALI IN CASSETTA PLASTICA

860 Pz. dal Diam. 2,3 al Diam. 19

MISURA	2,3	3,2	4	5	6	7	8	9	10	12	15	19
PEZZI	100	100	100	100	100	100	100	50	50	30	20	10

NS. CODICE

ASSORAD



## ANELLI SEEGER ESTERNI IN VALIGETTA PLASTICA

1915 Pz. dal Diam. 10 al Diam. 50

MISURA	10	11	12	13	14	15	16	17	18	19	20	22
PEZZI	100	100	100	100	100	100	100	100	100	100	100	100

MISURA	24	25	26	28	29	30	32	34	35	36	38	40
PEZZI	100	100	50	50	50	50	50	50	50	25	25	25

MISURA	42	45	48	50
--------	----	----	----	----

PEZZI	25	25	20	20
-------	----	----	----	----

NS. CODICE

ASSOANEST

## ANELLI SEEGER INTERNI IN VALIGETTA PLASTICA

1915 Pz. dal Diam. 10 al Diam. 50

MISURA	10	11	12	13	14	15	16	17	18	19	20	22
PEZZI	100	100	100	100	100	100	100	100	100	100	100	100

MISURA	24	25	26	28	30	32	35	36	37	38	40	42
PEZZI	100	100	50	50	50	50	50	50	50	25	25	25

MISURA	45	47	48	50
--------	----	----	----	----

PEZZI	25	25	20	20
-------	----	----	----	----

NS. CODICE

ASSOANINT



## SPINE ELASTICHE - UNI 6873 DIN 1481 - IN VALIGETTA PLASTICA

1145 Pz dal Diam. 3 al Diam 12

MISURA	3 x 20	3 x 30	3 x 40	4 x 20	4 x 40	5 x 30	5 x 50	6 x 20	6 x 40	6 x 60	6 x 80
PEZZI	100	100	100	100	100	100	100	50	50	50	50

MISURA	8 x 40	8 x 50	8 x 60	8 x 80	10 x 40	10 x 60	10 x 80
PEZZI	30	30	30	30	20	20	20

MISURA	10 x 100	12 x 60	12 x 80	12 x 100
PEZZI	20	15	15	15

NS. CODICE

ASSOSPIEL

## INGRASSATORI e TESTINE IN VALIGETTA PLASTICA

583 Pz -- 18 misure



doppio esagono



chiave 7 mm



tipo diritto - chiave 11 mm

PASSO	1/4	6 x 1	6 x 1	8 x 1	10 x 1	10 x 1,25	1/4
PEZZI	30	50	50	50	100	50	30



tipo a 45° - chiave 11 mm



tipo a 90° - chiave 11 mm

PASSO	8 x 1	8 x 1,25	10 x 1	10 x 1,25	1/4	8 x 1	8 x 1,25	10 x 1	1/4
PEZZI	30	30	30	30	15	20	20	30	10



per ingrassatori testa esagonale

PEZZI 3



testina **EXTRA** a 4 griffe regolabili

PEZZI 5

NS. CODICE

ASSOINGR



# ASSORTIMENTI DI ELICOLI in acciaio inox

**assortimento di utensili per la riparazione dei filetti da M 6 a M 10 composto da 87 pz**

## pezzi descrizione contenuto

- 25 **inserto filettato M 6 x 1 H 8**  
 1 punta elicoidale per M 6 - diametro 6,3  
 1 maschio per filettare M 6 x 1  
 1 utensile di montaggio per M 6  
 1 estrattore linguetta per M 6
- 25 **inserto filettato M 8 x 1.25 H 10,8**  
 1 punta elicoidale per M 8 - diametro 8,3  
 1 maschio per filettare M 8 x 1,25  
 1 utensile di montaggio per M 8  
 1 estrattore linguetta per M 7 / M 8

NS. CODICE ASSOELIC1

## pezzi descrizione contenuto

- 25 **inserto filettato M 10 x 1.5 H 13,5**  
 1 punta elicoidale per M 10 - diametro 10,4  
 1 maschio per filettare M 10 x 1,5  
 1 utensile di montaggio per M 10  
 1 estrattore linguetta per M 10



**assortimento di utensili per la riparazione dei filetti da M 5 a M 12 composto da 130 pz**

## pezzi descrizione contenuto

- 25 **inserto filettato M 5 x 0,8 H 6,7**  
 1 punta elicoidale per M 5 - diametro 5,2  
 1 maschio per filettare M 5 x 0,8  
 1 utensile di montaggio per M 5  
 1 estrattore linguetta per M 5
- 25 **inserto filettato M 6 x 1 H 8**  
 1 punta elicoidale per M 6 - diametro 6,3  
 1 maschio per filettare M 6 x 1  
 1 utensile di montaggio per M 6  
 1 estrattore linguetta per M 6
- 25 **inserto filettato M 8 x 1.25 H 10,8**  
 1 punta elicoidale per M 8 - diametro 8,3  
 1 maschio per filettare M 8 x 1,25  
 1 utensile di montaggio per M 8  
 1 estrattore linguetta per M 7 / M 8

NS. CODICE ASSOELIC2

## pezzi descrizione contenuto

- 25 **inserto filettato M 10 x 1.5 H 13,5**  
 1 punta elicoidale per M 10 - diametro 10,4  
 1 maschio per filettare M 10 x 1,5  
 1 utensile di montaggio per M 10  
 1 estrattore linguetta per M 10
- 10 **inserto filettato M 12 x 1.75 H 16,3**  
 1 punta elicoidale per M 12 - diametro 12,4  
 1 maschio per filettare M 12 x 1,75  
 1 utensile di montaggio per M 12  
 1 estrattore linguetta per M 12



Dati , descrizioni , illustrazioni riportati nel seguente catalogo , non sono impegnativi e nessuna responsabilità potrà derivare alla DE PALMA TRADE per effetto di loro modifiche, sostituzioni o migliorie che potranno essere effettuate anche senza reavviso.

## BOX ASSORTIMENTO O - RING

**MISURE IN POLLICI ( BRITISH) MATERIALE : NBR / FPM ( VITON )**

**30 MISURE PER UN TOTALE DI 382 PEZZI**

20 pz - 2.9 x 1.78	20 pz - 3.68 x 1.78	20 pz - 4.48 x 1.78	20 pz - 6.07 x 1.78	20 pz - 7.66 x 1.78
20 pz - 9.25 x 1.78	13 pz - 9.19 x 2.62	13 pz - 10.78 x 2.62	13 pz - 12.37 x 2.62	13 pz - 13.95 x 2.62
13 pz - 15.54 x 2.62	13 pz - 17.13 x 2.62	13 pz - 18.72 x 2.62	10 pz - 18.64 x 3.53	10 pz - 18.64 x 3.53
10 pz - 20.22 x 3.53	10 pz - 21.82 x 3.53	10 pz - 23.40 x 3.53	10 pz - 24.99 x 3.53	10 pz - 26.58 x 3.53
10 pz - 28.17 x 3.53	10 pz - 29.75 x 3.53	10 pz - 31.34 x 3.53	10 pz - 32.92 x 3.53	10 pz - 34.52 x 3.53
10 pz - 36.10 x 3.53	10 pz - 37.69 x 3.53	7 pz - 37.47 x 5.33	7 pz - 40.65 x 5.33	7 pz - 43.82 x 5.33

### MISURE IN POLLICI

CODICE	MATERIALE
<b>ASSORING1</b>	<b>NBR</b>
<b>ASSORING3</b>	<b>FPM</b>

**FPM COLORE NERO**



**FPM COLORE NERO**

### MISURE METRICHE

CODICE	MATERIALE
<b>ASSORING2</b>	<b>NBR</b>
<b>ASSORING4</b>	<b>FPM</b>

**MISURE METRICHE MATERIALE : NBR / FPM ( VITON )**

**30 MISURE PER UN TOTALE DI 404 PEZZI**

18 pz - 3 x 2	18 pz - 4 x 2	18 pz - 5 x 2	18 pz - 6 x 2	17 pz - 7 x 2
17 pz - 8 x 2	17 pz - 10 x 2	14 pz - 10 x 2,5	14 pz - 11 x 2,5	14 pz - 12 x 2,5
14 pz - 14 x 2,5	14 pz - 16 x 2,5	14 pz - 17 x 2,5	14 pz - 19 x 2,5	12 pz - 19 x 3
12 pz - 20 x 3	12 pz - 22 x 3	12 pz - 24 x 3	12 pz - 25 x 3	12 pz - 27 x 3
12 pz - 28 x 3	12 pz - 30 x 3	12 pz - 32 x 3	12 pz - 33 x 3	12 pz - 35 x 3
12 pz - 36 x 3	12 pz - 38 x 3	9 pz - 38 x 4	9 pz - 42 x 4	9 pz - 45 x 4



## CONTENITORI IN POLIETILENE SOVRAPPONIBILI

MISURE CONTENITORE			
	L	P	H
NS. CODICE			
2001	103	90	55
2002	103	165	83
2003	145	240	125
2004	207	345	165
2005	303	485	190



disponibili in colore verde

## CASSETTIERE SOVRAPPONIBILI

MISURE CASSETTIERA			
	L	P	H
NS. CODICE			
MADIA 1	600	68	78
MADIA 2	600	96	112
MADIA 3	600	140	168
MADIA 4	600	178	206
MADIA 5	600	210	242

N°CASSETTI
9
6
5
4
3

*Cassetti asportabili*

disponibili in colore verde





## PORTA MINUTERIE IN POLIPROPILENE

MISURE CONTENITORE			
	L	P	H. UTILE
NS. CODICE			
CLASS 19	190	155	27

12 vaschette asportabili



MISURE CONTENITORE			
	L	P	H. UTILE
NS. CODICE			
CLASS 41	400	340	56

12 divisori estraibili



## BIDONE CARRELLATO - RACCOLTA DIFFERENZIATA

CAPACITA' 120 Lt

CERTIFICATO UNI EN 840 - CON RUOTE DA 200 mm - PRODOTTO IN POLIETILENE AD ALTA DENSITA' RESISTENTE AGLI AGENTI CHIMICI, NON ATTACCABILE DAI PARASSITI, NON ASSORBE I LIQUIDI, E' LAVABILE E STERILIZZABILE.

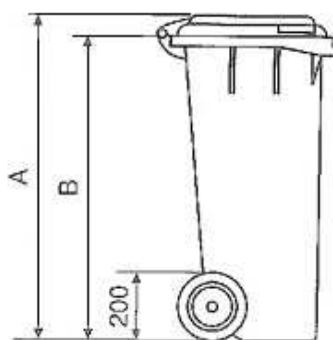

120 LITRI	
A	930 mm
B	875 mm
C	485 mm
D	550 mm
E	480 mm
F	355 mm
G	480 mm
PESOWEIGHT/PESO	11 kg

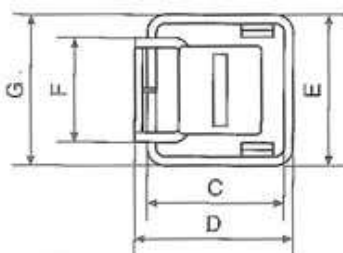

COLORI FORNIBILI

Bianco / Giallo / Verde / Blu

Marrone / Rosso / Grigio



# COPIGLIE FERRO UNI 1336 - DIN 94

MATERIALE :

Ferro FE 37

TRATTAMENTO SUPERFICIALE :

Grezze

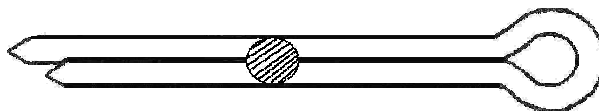

IL DIAMETRO NOMINALE DELLA COPIGLIA E' DA INTENDERSI, IL RELATIVO DIAMETRO DEL FORO PASSANTE

## DIAMETRO NOMINALE ( FORO )

M / M	1
M / M	1,6
M / M	2
M / M	2,5
M / M	3,2
M / M	3,5
M / M	4
M / M	4,5
M / M	5
M / M	6,3
M / M	7
M / M	8
M / M	10
M / M	12

CONFEZIONI DA 5 Kg

**E' POSSIBILE SCONFEZIONARE MA CON UN MINIMO DI 1 Kg E UN SOVRAPREZZO COME RIPOSTATO SUL LISTINO PREZZI**

## COPIGLIE ASSORTITE DAL DIAMETRO 1,6 AL 5

COPIASSO 05

CONFEZIONE DA 500 Grammi



## COPIGLIA SAGOMATA



	DIAMETRO mm
NS. CODICE	
COPSAG18	1,8
COPSAG20	2
COPSAG25	2,5
COPSAG30	3
COPSAG35	3,5
COPSAG40	4
COPSAG50	5
COPSAG60	6
COPSAG80	8

PER ALBERO mm
da 6 a 8
da 10 a 12
da 11 a 14
da 12 a 16
da 14 a 20
da 14 a 20
da 20 a 30
da 28 a 30

confezione  
pz

200
200
100
100
100
50
50
50
30

## COPIGLIA SCATTO

	DIAMETRO mm
NS. CODICE	
COPSCA05	5
COPSCA06	6
COPSCA07	7
COPSCA08	8
COPSCA09	9
COPSCA10	10
COPSCA11	11

PER ALBERO mm
da 14 a 18
da 18 a 22
da 22 a 28
da 22 a 28
da 26 a 32
da 28 a 36
da 30 a 38

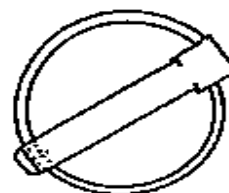

confezione  
pz

50
50
50
50
50
30
30

## COPIGLIE PER MOTOZAPPA

	DIAMETRO	L
NS. CODICE		
COPZAP0845	8	45
COPZAP0870	8	70
COPZAP1070	10	70
COPZAP1270	12	70

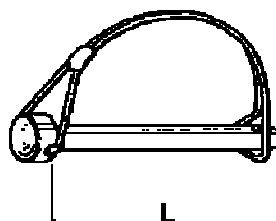

confezione  
pz

50
50
30
30



# DADI AUTOBLOCCANTI ALTI

con inserto in nylon

## UNI 7473 - DIN 982 - ISO 7040

TRATTAMENTO SUPERFICIALE :  
Zincato

CLASSE  
8



### PASSO GROSSO - MA

NS. CODICE	DIAMETRO	Altezza	Chiave
DAUA +	passo	mm	mm

04 MA	<b>4 x 0,7</b>	6	7
05 MA	<b>5 x 0,8</b>	6,8	8
06 MA	<b>6 x 1</b>	8	10
08 MA	<b>8 x 1,25</b>	9,5	13
10 MA	<b>10 x 1,5</b>	11,5	17
12 MA	<b>12 x 1,75</b>	14	19
14 MA	<b>14 x 2</b>	16	22
16 MA	<b>16 x 2</b>	18	24
18 MA	<b>18 x 2,5</b>	20	27
20 MA	<b>20 x 2,5</b>	22	30
22 MA	<b>22 x 2,5</b>	25	32
24 MA	<b>24 x 3</b>	27	36
27 MA	<b>27 x 3</b>	30	41
30 MA	<b>30 x 3,5</b>	32	46
33 MA	<b>33 x 3,5</b>	35	50
36 MA	<b>36 x 4</b>	39	55
39 MA	<b>39 x 4</b>	42	60
42 MA	<b>42 x 4,5</b>	45	65
45 MA	<b>45 x 4,5</b>	48	70
48 MA	<b>48 x 5</b>	52	75
52 MA	<b>52 x 5</b>	54	80

### PASSO FINE - MB

NS. CODICE	DIAMETRO	Altezza	Chiave
DAUA +	passo	mm	mm

10 MB	<b>10 x 1,25</b>	11,5	17
12 MB	<b>12 x 1,25</b>	14	19
12 15	<b>12 x 1,5</b>	14	19
14 MB	<b>14 x 1,5</b>	16	22
16 MB	<b>16 x 1,5</b>	18	24
18 MB	<b>18 x 1,5</b>	20	27
20 MB	<b>20 x 1,5</b>	22	30
22 MB	<b>22 x 1,5</b>	25	32
24 15	<b>24 x 1,5</b>	27	36
24 MB	<b>24 x 2</b>	27	36
27 MB	<b>27 x 2</b>	30	41
30 MB	<b>30 x 2</b>	32	46
33 MB	<b>33 x 2</b>	35	50
36 MB	<b>36 x 3</b>	39	55
39 MB	<b>39 x 3</b>	42	60
42 MB	<b>42 x 3</b>	45	65
45 MB	<b>45 x 3</b>	48	70
48 MB	<b>48 x 3</b>	52	75
52 MB	<b>52 x 3</b>	54	80

SONO FORNIBILI :

DADI BASSI  
DADI CON FILETTATURA A POLLICI  
DADI DI DIAMETRO SINO AL 100  
DADI V A R G A L



VARGAL



# DADI AUTOBLOCCANTI METALLICI ( CONE - LOCK )

DIN 980

TRATTAMENTO SUPERFICIALE : ZONA DEFORMATA PER PERMETTERE L'AZIONE FRENANTE

Zincato

CLASSE  
8



## PASSO GROSSO - MA

NS.CODICE	DIAMETRO passo	Altezza	Chiave
		mm	mm
DAUMET06MA	6 x 1	6	10
DAUMET08MA	8 x 1,25	8	13
DAUMET10MA	10 x 1,5	10	17
DAUMET12MA	12 x 1,75	12	19
DAUMET14MA	14 x 2	14	22
DAUMET16MA	16 x 2	16	24
DAUMET18MA	18 x 2,5	18	27
DAUMET20MA	20 x 2,5	20	30
DAUMET24MA	24 x 3	24	36

## PASSO FINE - MB

NS.CODICE	DIAMETRO passo	Altezza	Chiave
		mm	mm
DAUMET10MB	10 x 1,25	10	17
DAUMET12MB	12 x 1,25	12	19
DAUMET14MB	14 x 1,5	14	22
DAUMET16MB	16 x 1,5	16	24
DAUMET18MB	18 x 1,5	18	27
DAUMET20MB	20 x 1,5	20	30
DAUMET24MB	24 x 2	24	36



## DADI AD ALETTE UNI 5448 A

IN ACCIAIO ZINCATO

	DIAMETRO mm
NS. CODICE	
DDALFE04	4
DDALFE05	5
DDALFE06	6
DDALFE08	8
DDALFE10	10
DDALFE12	12
DDALFE14	14
DDALFE16	16



## DADI ESAGONALI CIECHI UNI 5721

IN ACCIAIO ZINCATO

	DIAMETRO mm
NS. CODICE	
DDCIECFE04	4
DDCIECFE05	5
DDCIECFE06	6
DDCIECFE08	8
DDCIECFE10	10
DDCIECFE12	12
DDCIECFE14	14
DDCIECFE16	16
DDCIECFE18	18
DDCIECFE20	20
DDCIECFE22	22
DDCIECFE24	24



## DADI ESAGONALI CIECHI IN OTTONE

	DIAMETRO mm
NS. CODICE	
DDCIECOT04	4
DDCIECOT05	5
DDCIECOT06	6
DDCIECOT08	8
DDCIECOT10	10
DDCIECOT12	12
DDCIECOT14	14
DDCIECOT16	16

CHIAVE :15 ALTEZZA:14



## DADI ESAGONALI di diametro oltre il 30

**UNI 5587 -- ISO 4033 -- Classe 8**

PASSO GROSSO			
DIAMETRO e PASSO mm		CHIAVE	ALTEZZA
		mm	mm
33	3,5	50	33
36	4	55	36
39	4	60	39
42	4,5	65	42
45	4,5	70	45
48	5	75	48
52	5	80	52
56	5,5	85	56
60	5,5	90	60
64	6	95	64
68	6	100	68

PASSO FINE			
DIAMETRO e PASSO mm		CHIAVE	ALTEZZA
		mm	mm
33	2	50	33
36	3	55	36
39	3	60	39
42	3	65	42
45	3	70	45
48	3	75	48
52	3	80	52
56	4	85	56
60	4	90	60

**UNI 5588 -- DIN 934 -- ISO 4032 -- Classe 8**

PASSO GROSSO			
DIAMETRO e PASSO mm		CHIAVE	ALTEZZA
		mm	mm
33	3,5	50	26
36	4	55	29
39	4	60	31
42	4,5	65	34
45	4,5	70	36
48	5	75	38
52	5	80	42
56	5,5	85	45
60	5,5	90	48
64	6	95	51
68	6	100	54

PASSO FINE			
DIAMETRO e PASSO mm		CHIAVE	ALTEZZA
		mm	mm
33	2	50	26
36	3	55	29
39	3	60	31
42	3	65	34
45	3	70	36
48	3	75	38
52	3	80	42
56	4	85	45
60	4	90	48

SONO FORNIBILI DADI CON DIAMETRO SINO AL 100 E UNI 5589 - 080 532 77 89

[info@depalmatrade.it](mailto:info@depalmatrade.it)





## DADI in OTTONE e ACCIAIO PER COLLETTORI E TUBI SCARICO



MATERIALE :

**Ottone**

NS. CODICE	DIAMETRO	PASSO	ALTEZZA
	mm	mm	mm
DOT06106	<b>6 x</b>	1 x	<b>6</b>
DOT08108	<b>8 x</b>	1 x	<b>8</b>
DOT08112	<b>8 x</b>	1 x	<b>12</b>
DOT08116	<b>8 x</b>	1 x	<b>16</b>
DOT0812565	<b>8 x</b>	1,25 x	<b>6,5</b>
DOT0812508	<b>8 x</b>	1,25 x	<b>8</b>
DOT0812510	<b>8 x</b>	1,25 x	<b>10</b>
DOT0812512	<b>8 x</b>	1,25 x	<b>12</b>
DOT0812516	<b>8 x</b>	1,25 x	<b>16</b>
DOT10112	<b>10 x</b>	1 x	<b>12</b>
DOT10120	<b>10 x</b>	1 x	<b>20</b>
DOT1012510	<b>10 x</b>	1,25 x	<b>10</b>
DOT1012515	<b>10 x</b>	1,25 x	<b>15</b>
DOT1012520	<b>10 x</b>	1,25 x	<b>20</b>
DOT101510	<b>10 x</b>	1,5 x	<b>10</b>
DOT101515	<b>10 x</b>	1,5 x	<b>15</b>
DOT101520	<b>10 x</b>	1,5 x	<b>20</b>
DOT1212515	<b>12 x</b>	1,25 x	<b>15</b>
DOT121520	<b>12 x</b>	1,5 x	<b>20</b>
DOT1217512	<b>12 x</b>	1,75 x	<b>12</b>

MATERIALE :

**Acciaio**

NS. CODICE	DIAMETRO	PASSO	ALTEZZA
	mm	mm	mm
DAC0812510	<b>8 x</b>	1,25 x	<b>10</b>
DAC0812512	<b>8 x</b>	1,25 x	<b>12</b>
DAC0812516	<b>8 x</b>	1,25 x	<b>16</b>
DAC1012510	<b>10 x</b>	1,25 x	<b>10</b>
DAC1012515	<b>10 x</b>	1,25 x	<b>15</b>
DAC1012520	<b>10 x</b>	1,25 x	<b>20</b>
DAC101515	<b>10 x</b>	1,5 x	<b>15</b>



# DADI A CORONA TORNITI

**UNI 5593 - DIN 935 - ( ALTI ) - Classe 8**

MATERIALE :  
Acciaio AVP - 11 SMnPb37

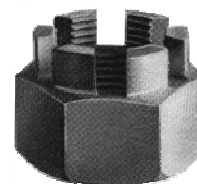

NS. CODICE	DIAMETRO	ALTEZZA	PASSO	PASSO
	mm		GROSSO	FINE
DD9310	10	12	1,5	1,25
DD9312	12	15	1,75	1,25
DD9314	14	16	2	1,5
DD9316	16	19	2	1,5
DD9318	18	21	2,5	1,5
DD9320	20	22	2,5	1,5
DD9322	22	26	2,5	1,5
DD9324	24	27	3	2
DD9327	27	30	3	2
DD9330	30	33	3,5	2
DD9333	33	35	3,5	2
DD9336	36	38	4	3
DD9339	39	40	4	3
DD9342	42	46	4,5	3
DD9345	45	48	4,5	3
DD9348	48	50	5	3
DD9352	52	54	5	3
DD931UNC	1"		UNC	

**UNI 5594 - ( BASSI ) - Classe 8**

NS. CODICE	DIAMETRO	ALTEZZA	PASSO	PASSO
	mm		GROSSO	FINE
DD9416	16	14	2	1,5
DD9418	18	15	2,5	1,5
DD9420	20	15	2,5	1,5
DD9422	22	18	2,5	1,5
DD9424	24	18	3	2
DD942415	24	18		1,5
DD9427	27	20	3	2
DD9430	30	21	3,5	2
DD9433	33	22	3,5	2
DD9436	36	23	4	3

AL NS. CODICE BISOGNA AGGIUNGERE **MA** PER IL PASSO GROSSO **MB** PER IL PASSO FINE



# DADI FLANGIATI ZIGRINATI

## DIN 6923 - ISO 4161

TRATTAMENTO SUPERFICIALE :  
Zincato

CLASSE  
8

**Flangia liscia su richiesta**

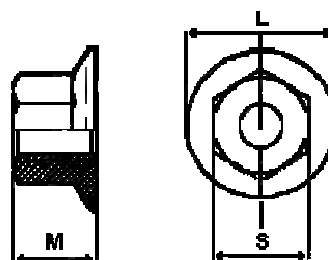

NS.CODICE

DIAMETRO  
passo

L	M	S
mm	mm	mm

DDFL05MA
DDFL06MA
DDFL08MA
DDFL10MA
DDFL12MA

5 x 0,8
6 x 1
8 x 1,25
10 x 1,5
12 x 1,75

12	5	8
14,2	6	10
17,9	8	13
21,8	10	15
26	12	18

# DADI FLANGIATI AUTOBLOCCANTI

con inserto in nylon

## DIN 6926

TRATTAMENTO SUPERFICIALE :  
Zincato

CLASSE  
8

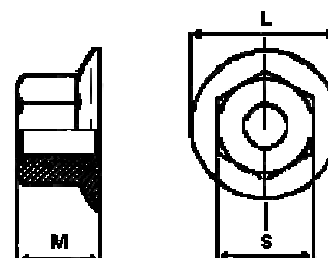

NS.CODICE

DIAMETRO  
passo

L	M	S
mm	mm	mm

DDFLAU05MA
DDFLAU06MA
DDFLAU08MA
DDFLAU10MA
DDFLAU12MA
DDFLAU14MA

5 x 0,8
6 x 1
8 x 1,25
10 x 1,5
12 x 1,75
14 x 2

12	7	8
14,2	9	10
17,9	11	13
21,8	13,5	15
26	16	18
26		18



# DADI GIUNZIONE

## DIN 6334

TRATTAMENTO SUPERFICIALE :  
Zincato

CLASSE  
8

PASSO GROSSO



NS.CODICE	DIAMETRO	L		S	
		mm		mm	
DDGI0515	5	25	8		
DDGI0630	6	30	10		
DDGI0640	6	40	10		
DDGI0830	8	30	13		
DDGI0840	8	40	13		
DDGI1030	10	30	17		
DDGI1045	10	45	17		
DDGI1236	12	36	19		
DDGI1250	12	50	19		
DDGI1648	16	48	24		
DDGI1660	16	60	24		
DDGI2060	20	60	30		
DDGI2472	24	72	36		

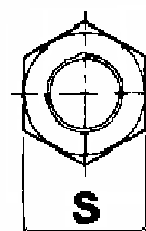
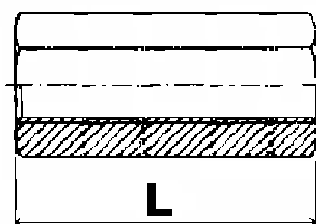

SONO FORNIBILI BARRE DI LUNGHEZZA 2 Mt. E 3 Mt. - 080 532 77 89 - info@depalmatrade.it





# FASCETTE A BULLONE IN ACCIAIO ZINCATO

MATERIALE :  
Acciaio

TRATTAMENTO SUPERFICIALE :  
Zincatura trivalente esente cromo VI



**Inox su richiesta**

CAPACITA' SERRAGGIO	LARGHEZZA BANDA	SPESSORE BANDA	VITE Res. 8.8	COPPIA SERRAGGIO
	DIMENSIONI IN m/m			Nm
23 - 25	18	0,6	5 MA	10
26 - 28			6 MA	
29 - 31	20	0,8		
32 - 35				
36 - 39	22	1,2		
40 - 43				
44 - 47				
48 - 51				
52 - 55	24	1,5	10 MA	23
56 - 59				
60 - 63				
64 - 67				
68 - 73				
74 - 79				
80 - 85	26	1,7	10 MA	46
86 - 91				
92 - 97				
98 - 103				
104 - 112				
113 - 121				
122 - 130				
131 - 140				
140 - 148				
149 - 161				
162 - 174				
175 - 187				
188 - 200				
201 - 213				
214 - 227				
227 - 239				
240 - 252				

LA TIPOLOGIA RIPORTATA E' SOLTANTO QUELLA NORMALMENTE DISPONIBILE PRESSO IL NS. MAGAZZINO. SONO FORNIBILI SU RICHIESTA SVARIATI PRODOTTI E SOLUZIONI PER IL SERRAGGIO E CABLAGGIO .

080 532 77 24 - [info@depalmatrade.it](mailto:info@depalmatrade.it)



# FASCETTE PER CABLAGGIO IN NYLON

MATERIALE :  
Nylon 6.6

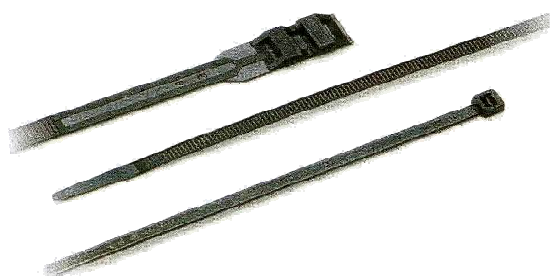

## NYLON BIANCO

NS. CODICE	LARG. x LUNG. mm	TENUTA MIN. Nm	Ø MAX. UTILE mm	BUSTA pz
FNB36140	3,6 x 140	180	34	100
FNB36200	3,6 x 200		50	
FNB48200	4,8 x 200	220	50	
FNB48300	4,8 x 300		75	
FNB48360	4,8 x 360		100	
FNB48430	4,8 x 430		115	

## NYLON NERO

NS. CODICE	LARG. x LUNG. mm	TENUTA MIN. Nm	Ø MAX. UTILE mm	BUSTA pz
FNN25098	2,5 x 98	60	19	100
FNN36140	3,6 x 140	180	34	
FNN36200	3,6 x 200		50	
FNN48200	4,8 x 200	220	50	
FNN48300	4,8 x 300		75	
FNN48360	4,8 x 360		100	
FNN48430	4,8 x 430		115	
FNN78300	7,8 x 300	540	75	
FNN78365	7,8 x 365		100	
FNN78540	7,8 x 540		160	
FNN78750	7,8 x 750		220	

PER INFORMAZIONI SULLE CARATTERISTICHE TECNICHE : 080 532 77 24 - [info@depalmtrade.it](mailto:info@depalmtrade.it)

SONO FORNIBILI SU RICHIESTA SVARIATI PRODOTTI E SOLUZIONI PER IL SERRAGGIO E CABLAGGIO

080 532 77 24 - [info@depalmtrade.it](mailto:info@depalmtrade.it)





## FASCETTA STRINGITUBO CON VITE

Fascetta con banda piena realizzata secondo norma DIN 3017  
bordi della banda sono arrotondati per evitare danneggiamenti al tubo

MATERIALI :

Banda e cassetto in ACCIAIO INOX

Vite in acciaio zincato bianco esente da cromo VI.



NS. CODICE	LARGHEZZA	CAPACITA'	COPPIA
	BANDA	SERRAGGIO	SERRAGGIO
	mm	mm	Nm

H05007011	<b>5</b>	7 - 11	
H05009014		9 - 14	
H05010019		10 - 19	

H09010016	<b>9</b>	8 - 12	<b>5</b>
H09010016		10 - 16	
H09012022		12 - 22	
H09016027		16 - 27	
H09023035		23 - 35	
H09025040		25 - 40	
H09032050		32 - 50	
H09040060		40 - 60	
H09050070		50 - 70	
H09060080		60 - 80	
H09070090		70 - 90	
H09080100		80 - 100	
H09090110		90 - 110	
H09100120		100 - 120	
H09110130		110 - 130	
H09120140		120 - 140	
H09130150	130 - 150		

NS. CODICE	LARGHEZZA	CAPACITA'	COPPIA
	BANDA	SERRAGGIO	SERRAGGIO
	mm	mm	Nm

H12016027	<b>13</b>	16 - 27	
H12023035		23 - 35	
H12025040		25 - 40	
H12032050		32 - 50	
H12040060		40 - 60	
H12050070		50 - 70	
H12060080		60 - 80	
H12070090		70 - 90	
H12080100		80 - 100	
H12090110		90 - 110	
H12100120		100 - 120	
H12110130		110 - 130	
H12120140		120 - 140	
H12130150		130 - 150	
H12140160		140 - 160	
H12150170		150 - 170	
H12160180		160 - 180	
H12170190		170 - 190	
H12180200		180 - 200	
H12200220		200 - 220	
H12220240	220 - 240		
H12240260	240 - 260		

PER INFORMAZIONI SULLE CARATTERISTICHE TECNICHE : 080 532 71 98 - info@depalmtrade.it

SONO FORNIBILI SU RICHIESTA SVARIATI PRODOTTI E SOLUZIONI PER IL SERRAGGIO E CABLAGGIO

**080 532 77 24 - info@depalmtrade.it**



# GHIERE AUTOBLOCCANTI

TIPO NORMALE CON INSERTO IN NYLON

TRATTAMENTO SUPERFICIALE :

Zincato

CLASSE :

8



NS.CODICE	DIAMETRO e PASSO	ALTEZZA   N°CAVE	
		mm	
GHIAUT010	10 x 0,75	7,4	4
GHIAUT012	12 x 1	7,4	4
GHIAUT015	15 x 1	8,4	4
GHIAUT017	17 x 1	8,4	4
GHIAUT020	20 x 1	9,4	4
GHIAUT025	25 x 1,5	10,3	4
GHIAUT030	30 x 1,5	10,9	4
GHIAUT035	35 x 1,5	11,1	4
GHIAUT040	40 x 1,5	12,1	4
GHIAUT045	45 x 1,5	12,1	4
GHIAUT050	50 x 1,5	12,7	4
GHIAUT055	55 x 2	13,2	6
GHIAUT060	60 x 2	13,3	6
GHIAUT065	65 x 2	14,3	6
GHIAUT070	70 x 2	14,3	6
GHIAUT075	75 x 2	15,3	6
GHIAUT080	80 x 2	16,3	8
GHIAUT085	85 x 2	17,3	8
GHIAUT090	90 x 2	17,5	8
GHIAUT095	95 x 2	18,3	8
GHIAUT100	100 x 2	19,3	8

SONO FORNIBILI SU RICHIESTA SVARIATI TIPI DI GHIERE CON E SENZA ANELLO IN PLASTICA .

080 532 77 24 - [info@depalmatrade.it](mailto:info@depalmatrade.it)



# GUANTI da lavoro

## GUANTO SPALMATO NITRILE Cat. 2

Guanto in nylon elastico con palmo e dita ricoperti in nitrile , dorso traspirante , polso elasticizzato

Molto aderente e sensibile , ottima presa antiscivolo  
alta resistenza all'abrasione e allo strappo.

Lavori di precisione, magazzino, assemblaggio ,  
giardinaggio, meccanica, bricolage, edilizia, idraulica.

NS. CODICE	A 112
Taglie disponibili	8 - 9 - 10



## GUANTO NBR GIALLO Cat. 2

Guanto in cotone - palmo dita e nocche ricoperti in nitrile NBR giallo, dorso traspirante , polso elasticizzato

Resistente agli olii, grassi e lubrificanti

Lavori di industria meccanica , manipolazione oggetti  
bagnati o grassi , magazzino, agricoltura .

NS. CODICE	A 113
Taglie disponibili	8 - 9 - 10



## GUANTO NBR BLU Cat. 2

Guanto in cotone - interamente rivestito in NBR blu - manichetta di sicurezza rigida in tela di cotone

Alta resistenza al taglio, agli olii, grassi e lubrificanti,  
ottima presa antiscivolo

Lavori di industria meccanica , manipolazione oggetti  
bagnati o grassi , magazzino, agricoltura .

NS. CODICE	A 122
Taglie disponibili	9 - 10



# GUANTI da lavoro

## GUANTO MONOUSO NITRILE con polvere

Cat. 1

Eccellente elasticità, alta resistenza ai detersivi ,  
idrocarburi e solventi .

Lavori di meccanica e carrozzeria ,laboratori di analisi  
parrucchieri,farmaceutici,lavori di pulizia .

NS. CODICE	A 131
Taglie disponibili	M - L - XL



## GUANTO MONOUSO NITRILE con polvere elevato spessore

Cat. 3

Consigliato per lavori ad alto rischio .

Eccellente elasticità, alta resistenza ai detersivi ,  
idrocarburi e solventi .

Lavori di meccanica e carrozzeria ,laboratori di analisi  
parrucchieri,farmaceutici,lavori di pulizia .

NS. CODICE	A 147
Taglie disponibili	M - L - XL

**PER RICEVERE IL CATALOGO COMPLETO DELL'ANTINFORTUNISTICA CONTATTATE**

**IL NS. AGENTE DI ZONA O INViateci RICHIESTA A [INFO@DEPALMATRADE.IT](mailto:INFO@DEPALMATRADE.IT)**



# CASSETTE MEDICHE - PRONTO SOCCORSO

## VALIGIA IN POLIPROPILENE CON SUPPORTO A MURO



ALLEGATO 1  
Per attività con oltre 2 persone

NS. CODICE S 404

ALLEGATO 2  
Per attività sino a 2 persone

NS. CODICE S 403

## ARMADIETTO PENSILE IN METALLO



ALLEGATO 1  
Per attività con oltre 2 persone

NS. CODICE S 407



## SAPONI IN PASTA E LIQUIDI

### SAPONE IN PASTA - PROFESSIONALE

**Detergente sgrassante al profumo di limone ideale per ogni tipo di sporco difficile.  
Consigliato per tutti, professionisti e amanti del fai da te.  
Lascia le mani morbide e profumate anche dopo un uso frequente.**

COD.	0505
COD.	0507

CONFEZIONE DA 1 KG  
CONFEZIONE DA 4 KG



### SAPONE FLUIDO - PROFESSIONALE

**Pasta lavamani fluida ad elevato potere detergente.  
Ideale per ogni tipo di sporco .  
Specifica per utilizzo con dosatori.**

COD.	0510
COD.	0515

CONFEZIONE DA 1 LT  
CONFEZIONE DA 5 LT



# LINGUETTE RETTANGOLARI

UNI 6604 A - DIN 6885 A - ISO 773 A

MATERIALE :

C 45 K

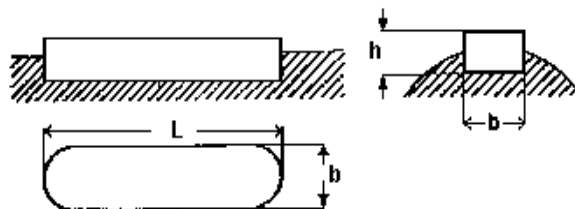

NS. CODICE	MISURA		
	mm		
	b	h	L

LR0404025	4	4	25
LR0404030	4	4	30
LR0404040	4	4	40
LR0404050	4	4	50

LR0505020	5	5	20
LR0505025	5	5	25
LR0505030	5	5	30
LR0505035	5	5	35
LR0505040	5	5	40
LR0505050	5	5	50
LR0505060	5	5	60
LR0505070	5	5	70

LR0606025	6	6	25
LR0606030	6	6	30
LR0606035	6	6	35
LR0606040	6	6	40
LR0606050	6	6	50
LR0606060	6	6	60

LR0807035	8	7	35
LR0807040	8	7	40
LR0807050	8	7	50
LR0807060	8	7	60
LR0807070	8	7	70
LR0807080	8	7	80
LR0807090	8	7	90
LR0807100	8	7	100
LR0807120	8	7	120
LR0807130	8	7	130

NS. CODICE	MISURA		
	mm		
	b	h	L

LR1008025	10	8	25
LR1008030	10	8	30
LR1008035	10	8	35
LR1008040	10	8	40
LR1008050	10	8	50
LR1008060	10	8	60
LR1008070	10	8	70
LR1008080	10	8	80
LR1008100	10	8	100
LR1008120	10	8	120

LR1208030	12	8	30
LR1208040	12	8	40
LR1208050	12	8	50
LR1208060	12	8	60
LR1208070	12	8	70
LR1208080	12	8	80
LR1208090	12	8	90
LR1208100	12	8	100

LR1409050	14	9	50
LR1409060	14	9	60
LR1409070	14	9	70
LR1409080	14	9	80
LR1409090	14	9	90
LR1409100	14	9	100

LR1610060	16	10	60
LR1610070	16	10	70
LR1610080	16	10	80
LR1610100	16	10	100





# PRIGIONIERI

NS. CODICE	DIMENSIONI PRIGIONIERO				confezione pz	
	MISURA mm	PASSO	A mm	B mm		C mm
PRIGNR01	5 x 21	0,8	7	3	11	100
PRIGNR02	5 x 25	0,8	7	7	11	100
PRIGNR03	5 x 30	0,8	7	7	16	100
PRIGNR05	5 x 40	0,8	7	17	16	50
PRIGNR06	5 x 50	0,8	7	27	16	50
PRIGNR09	5 x 60	0,8	13	31	16	50
PRIGNR13	5 x 70	0,8	13	41	16	30
PRIGNR07	6 x 21	1	9	3	9	50
PRIGNR08	6 x 25	1	9	3	13	50
PRIGNR10	6 x 27	1	9	4	14	50
PRIGNR11	6 x 29	1	12	5	12	50
PRIGNR12	6 x 32	1	12	4	16	50
PRIGNR14	6 x 36	1	16	4	16	50
PRIGNR16	6 x 39	1	9	12	18	50
PRIGNR17	6 x 45	1	12	15	18	50
PRIGNR18	6 x 49	1	9	24	16	50
PRIGNR19	6 x 54	1	15	21	18	30
PRIGNR20	6 x 56	1	15	23	18	30
PRIGNR21	6 x 58	1	15	25	18	30
PRIGNR22	6 x 64	1	9	37	18	30
PRIGNR24	6 x 70	1	15	37	18	30
PRIGNR27	7 x 26	1	8	3	15	50
PRIGNR28	7 x 28	1	10	3	15	50
PRIGNR29	7 x 35	1	12	8	15	50
PCLNR101	8 x 26	1,25	12	2	12	50
PCLNR103	8 x 28	1,25	12	3	13	50
PCLNR105	8 x 30	1,25	12	3	15	50
PCLNR107	8 x 32	1,25	12	3	17	50
PCLNR109	8 x 34	1,25	12	3	19	50
PCLNR121	8 x 37	1,25	12	5	20	50
PCLNR127	8 x 38	1,25	15	8	15	50
PCLNR129	8 x 40	1,25	12	8	20	50
PCLNR137	8 x 42	1,25	12	10	20	50
PCLNR143	8 x 45	1,25	20	5	20	50
PCLNR155	8 x 47	1,25	12	13	22	50
PCLNR157	8 x 50	1,25	10	19	21	30
PCLNR169	8 x 55	1,25	20	13	22	30
PCLNR182	8 x 60	1,25	20	18	22	30
PBLNR201	8 x 62	1,25	12	28	22	30
PCLNR187	8 x 65	1,25	20	23	22	30
PCLNR193	8 x 70	1,25	20	28	22	30
PCLNR194	8 x 75	1,25	20	33	22	30
PCLNR199	8 x 81	1,25	16	44	21	20
PCLNR200	8 x 85	1,25	20	43	22	20
PBLNR209	8 x 91	1,25	16	49	26	20
PBLNR213	8 x 99	1,25	20	33	46	20
PCLNR203	8 x 106	1,25	16	64	26	20

LE DIMENSIONI DEI PRIGIONIERI POSSONO SUBIRE DELLE VARIAZIONI A DISCREZIONE DEL COSTRUTTORE

# PRIGIONIERI

NS. CODICE	DIMENSIONI PRIGIONIERO					confezione pz
	MISURA mm	PASSO	A mm	B mm	C mm	
PST10030	10 x 30	1,5	10	10	10	50
PCLNR204	10 x 33	1,25	15	3	15	50
PCLNR206	10 x 35	1,25	15	3	17	50
PST10035	10 x 35	1,5	15	3	17	50
PCLNR205	10 x 40	1,25	15	3	22	50
PST10040	10 x 40	1,5	15	3	22	50
PCLNR209	10 x 45	1,25	20	3	22	50
PST10045	10 x 45	1,5	15	5	25	50
PCLNR211	10 x 50	1,25	15	10	25	30
PST10050	10 x 50	1,5	15	11	24	30
PCLNR213	10 x 55	1,25	15	15	25	30
PST10055	10 x 55	1,5	15	15	25	30
PCLNR217	10 x 60	1,25	15	20	25	30
PST10060	10 x 60	1,5	15	20	25	30
PCLNR218	10 x 65	1,25	25	15	25	30
PST10065	10 x 65	1,5	15	25	25	30
PBLNR223	10 x 70	1,25	20	25	25	20
PST10070	10 x 70	1,5	15	30	25	20
PST10075	10 x 75	1,5	20	35	20	20
PCLNR221	10 x 80	1,25	15	40	25	20
PST10080	10 x 80	1,5	15	40	25	20
PCLNR225	10 x 85	1,25	15	45	25	20
PST10085	10 x 85	1,5	12	45	25	20
PCLNR229	10 x 90	1,25	15	50	25	20
PST10090	10 x 90	1,5	15	50	25	20
PBLNR237	10 x 95	1,25	15	55	25	20
PST10095	10 x 95	1,5	15	55	25	20
PCLNR235	10 x 100	1,25	25	50	25	20
PBLNR239	10 x 105	1,25	15	60	30	10
PCLNR237	10 x 110	1,25	20	60	30	10
PCLNR239	10 x 115	1,25	25	65	25	10
PST10115	10 x 115	1,5	15	68	32	10
PCLNR241	10 x 120	1,25	15	75	30	10
PCLNR243	10 x 125	1,25	15	80	30	10
PTCNR301	Rif. 986951 10 x 218	1,25	Testata FIAT 500 - 500D - 500F			10

LE DIMENSIONI DEI PRIGIONIERI POSSONO SUBIRE DELLE VARIAZIONI A DISCREZIONE DEL COSTRUTTORE



# PRIGIONIERI

NS. CODICE	DIMENSIONI PRIGIONIERO					confezione pz
	MISURA mm	PASSO	A mm	B mm	C mm	
PST12035	12 x 35	1,75	18	6	11	30
PST12040	12 x 40	1,75	16	6	18	30
PST12043	12 x 43	1,5	18	3	22	30
PSMNR632	12 x 46	1,5	18	3	25	30
PST12048	12 x 48	1,75	18	3	27	30
PST12052	12 x 53	1,25	18	6	29	30
PSMNR634	12 x 53	1,5	18	7	28	30
PST12053	12 x 53	1,75	18	12	23	30
PST12055	12 x 55	1,25	15	15	25	30
PBLNR247	12 x 55	1,5	30	3	22	30
PSMNR635	12 x 58	1,5	18	12	28	30
PST12058	12 x 58	1,75	18	12	28	30
PSMNR636	12 x 63	1,25	18	16	29	30
PST12064	12 x 63	1,5	18	17	28	30
PST12063 simile 5911	12 x 63	1,75	18	15	30	30
PST12070	12 x 68	1,25	18	21	29	30
PST12068	12 x 68	1,75	18	22	28	30
PBLNR243	12 x 70	1,5	30	12	28	20
PST12073 simile 5911	12 x 73	1,75	18	25	30	20
PST12077	12 x 78	1,25	18	31	29	20
PST12078 simile 5911	12 x 78	1,75	18	30	30	20
PST12080	12 x 80	1,5	30	22	28	20
PST12083 simile 5911	12 x 83	1,75	18	35	30	20
PST12085	12 x 85	1,5	30	27	28	20
PST12088 simile 5911	12 x 88	1,75	18	40	30	20
PST12090	12 x 90	1,5	30	32	28	20
PST12093	12 x 93	1,75	24	33	36	10
PBLNR245	12 x 95	1,5	30	37	28	10
PST12097	12 x 98	1,25	18	51	29	10
PST12099	12 x 98	1,5	18	52	28	10
PST12098 simile 5911	12 x 98	1,75	18	50	30	10
PST12103	12 x 103	1,75	24	49	30	10
PSMNR638	14 x 50	1,5	20	3	27	20
PST14050	14 x 50	2	20	3	27	20
PSMNR643	14 x 55	1,5	20	5	30	20
PST14055	14 x 55	2	28	8	19	20
PSMNR639	14 x 60	1,5	20	7	33	20
PST14060	14 x 60	2	21	6	33	20
PSMNR642	14 x 70	1,5	20	20	30	10
PST14070	14 x 70	2	21	16	33	10
PST14074	14 x 75	1,5	35	7	33	10
PST14075	14 x 75	2	21	21	33	10
PST14081	14 x 80	1,5	20	30	30	10
PST14080	14 x 80	2	21	26	33	10
PST14085	14 x 85	1,5	20	35	30	10
PST14089	14 x 90	1,5	20	37	33	10
PST14090	14 x 90	2	21	36	33	10
PST14100	14 x 100	1,5	20	47	33	10
PST14110	14 x 110	1,5	20	52	38	10
PTCNR331	14 x 170	AD ESAURIMENTO - 642 N2 - 6				10
PST14180	14 x 180	1,5	38	102	38	10
PTCNR333	14 x 205	1,5	40	125	40	10

LE DIMENSIONI DEI PRIGIONIERI POSSONO SUBIRE DELLE VARIAZIONI A DISCREZIONE DEL COSTRUTTORE

# PRIGIONIERI

NS. CODICE	DIMENSIONI PRIGIONIERO					confezione pz
	MISURA mm	PASSO	A mm	B mm	C mm	
PST16040	16 x 40	2	16	4	20	30
PST16045	16 x 45	2	16	4	25	30
PST16050	16 x 50	2	16	8	26	30
PST16051	16 x 51	1,5	32	5	14	20
PST16056	16 x 56	2	21	7	28	20
PST16057	16 x 57	1,5	22	3	32	20
PST16061	16 x 62	1,5	22	3	37	20
PST16068	16 x 67	1,5	22	8	37	20
PST16067	16 x 67	2	22	8	37	20
PST16077	16 x 77	1,5	22	18	37	10
PST16083	16 x 82	1,5	22	23	37	10
PST16082	16 x 82	2	22	20	38	10
PST16087	16 x 87	1,5	22	28	37	10
PST16092	16 x 92	2	22	32	38	10
PST16095	16 x 95	1,5	40	18	37	10
PST16100	16 x 100	2	24	36	40	10
PST10102	16 x 102	1,5	22	43	37	10
PST16112	16 x 112	1,5	22	53	37	10
PTCNR414	16 x 310	OM MOTORE CO3				
PTCNR419	16 x 335	OM MOTORE CO3				
PTCNR381	16 x 353	OM LUPETTO - LEONCINO - TIGROTTO				
PTCNR379	16 x 370	OM LUPETTO - LEONCINO - TIGROTTO				
PTCNR389	16	1,5	DADO CIECO PER PRIG. T.C. - CH 27			
PST18070	18 x 70	1,5	25	4	41	10
PST18075	18 x 75	2,5	24	15	36	10
PST18085	18 x 85	1,5	25	19	41	10
PST18090	18 x 90	2,5	26	26	38	10
PST18096	18 x 96	1,5	36	18	42	10
PST18230	18 x 230	** 2 **	speciale			
PST20078	20 x 78	1,5	28	5	45	5
PST20088	20 x 88	1,5	28	15	45	5

LE DIMENSIONI DEI PRIGIONIERI POSSONO SUBIRE DELLE VARIAZIONI A DISCREZIONE DEL COSTRUTTORE

LE MISURE RIPORTATE SONO SOLTANTO QUELLE DI USO COMUNE NORMALMENTE DISPONIBILI PRESSO IL NS MAGAZZINO  
SONO FORNIBILI SU RICHIESTA ALTRE MISURE - 080 532 71 98 - info@depalmatrade.it



# PRIGIONIERI MAGGIORATI

NS. CODICE	MISURA mm	confezione pz	NS. CODICE	MISURA mm	confezione pz
PRCRMG00	5 / 6 x 25	50	PCLMG173	8/10 x 55	20
PRCRMG01	5 / 6 x 30	50	PBLMG205	8/10 x 62	20
PRCRMG03	5 / 6 x 35	50	PCLMG191	8/10 x 65	10
PRCRMG04	5 / 6 x 40	50	PBLMG211	8/10 x 67	10
PRCRMG05	6 / 7 x 21	50	PCLMG197	8/10 x 70	10
PRCRMG06	6 / 7 x 23	50	PBLMG216	8/10 x 75	10
PRCRMG08	6 / 7 x 27	50	PBLMG217	8/10 x 98	10
PRCRMG09	6 / 7 x 30	50	PBLMG225	10/11 x 70	10
PRCRMG10	6 / 7 x 35	30	PBLMG230	10/11 x 85	10
PRCRMG11	6 / 7 x 40	30	PCLMG207	10/12 x 40	10
PRCRMG12	6 / 7 x 45	30	PCLMG215	10/12 x 55	10
PRCRMG13	6 / 7 x 50	30	PCLMG217	10/12 x 65	10
PRCRMG14	6 / 7 x 54	30	PBLMG227	10/12 x 70	10
PRCRMG15	6 / 7 x 58	20	PBLMG226	10/12 x 85	10
PRCRMG16	6 / 7 x 60	20	PCLMG231	10/12 x 90	10
PRCRMG17	6 / 7 x 66	20	PCLMG235	10/12 x 98	10
PRCRMG18	6 / 7 x 70	20			
PCLMG112	8/ 9 x 28	30	PSMMG637	12/14 x 63	
PCLMG113	8/ 9 x 34	30	PSMMG641	14/16 x 60	
PCLMG123	8/ 9 x 37	30	PSMMG642	14/16 x 70	
PCLMG131	8/ 9 x 40	30	PTCMG399	16/18 x 298	
PCLMG147	8/ 9 x 45	30	PTCMG397	16/18 x 315	
PCLMG159	8/ 9 x 50	20	PTCMG395	16/18 x 337	
PCLMG165	8/ 9 x 52	20	PTCMG393	16/18 x 353	
PCLMG171	8/ 9 x 54	20			
PCLMG183	8/ 9 x 60	20			
PBLMG203	8/ 9 x 62	20			
PCLMG189	8/ 9 x 65	10			
PBLMG209	8/ 9 x 67	10			
PCLMG195	8/ 9 x 70	10			
PBLMG213	8/ 9 x 75	10			
PBLMG215	8/ 9 x 98	10			
PCLMG110	8/10 x 28	50			
PCLMG117	8/10 x 34	50			
PCLMG125	8/10 x 37	30			
PCLMG133	8/10 x 40	30			
PCLMG149	8/10 x 45	30			
PCLMG161	8/10 x 50	30			
PCLMG167	8/10 x 52	30			

LE MISURE RIPORTATE SONO SOLTANTO QUELLE DI USO COMUNE NORMALMENTE DISPONIBILI PRESSO IL NS MAGAZZINO

080 532 77 24 - [info@depalmatrade.it](mailto:info@depalmatrade.it)



## RACCORDI FORATI IN ACCIAIO PASSAGGIO GASOLIO / OLIO

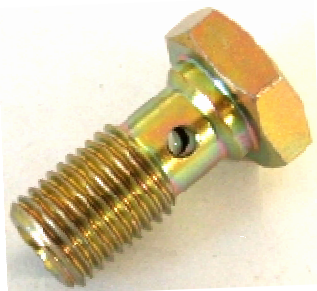

NS. CODICE	Ø mm	passo
RACCFO01	6	1
RACCFO02	8	1
RACCFO03	8	1,25
RACCFO04	10	1
RACCFO05	10	1,25
RACCFO06	10	1,5
RACCFO20	12	1
RACCFO08	12	1,25
RACCFO07	12	1,5
RACCFO21	14	1,25
RACCFO09	14	1,5

NS. CODICE	Ø mm	passo
RACCFO10	16	1,5
RACCFO11	18	1,5
RACCFO12	20	1,5
RACCFO13	22	1,5
RACCFO14	24	1,5
RACCFO22	24	2
RACCFO15	26	1,5
RACCFO16	28	1,5
RACCFO17	30	1,5

## SPINE FORATE PER FORCELLINI

NS. CODICE	Ø mm	L
SPIFOR0510	5	10
SPIFOR0515		15
SPIFOR0518		18
SPIFOR0615	6	15
SPIFOR0618		18
SPIFOR0620		20
SPIFOR0625		25
SPIFOR0627		27
SPIFOR0632		32
SPIFOR0635		35
SPIFOR0815	8	15
SPIFOR0820		20
SPIFOR0822		22
SPIFOR0825		25
SPIFOR0830		30
SPIFOR0837		37
SPIFOR0842		42

NS. CODICE	Ø mm	L
SPIFOR1020	10	20
SPIFOR1025		25
SPIFOR1030		30
SPIFOR1035		35
SPIFOR1040		40
SPIFOR1230	12	30
SPIFOR1235		35
SPIFOR1243		43
SPIFOR1435	14	35
SPIFOR1440		40
SPIFOR1450		50
SPIFOR1640	16	40

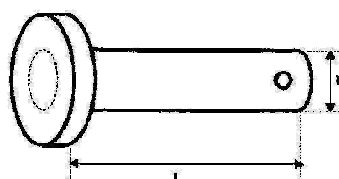

# TAPPI MONOBLOCCO

## TAPPI a BICCHIERE in acciaio

NS. CODICE	DIAMETRO mm
------------	----------------

TAPBIC 08	8
TAPBIC 10	10
TAPBIC 12	12
TAPBIC 14	14
TAPBIC 16	16
TAPBIC 18	18
TAPBIC 20	20
TAPBIC 22	22
TAPBIC 24	24
TAPBIC 25	25
TAPBIC 26	26
TAPBIC 28	28



NS. CODICE	DIAMETRO mm
------------	----------------

TAPBIC 30	30
TAPBIC 32	32
TAPBIC 34	34
TAPBIC 36	36
TAPBIC 38	38
TAPBIC 40	40
TAPBIC 42	42
TAPBIC 45	45
TAPBIC 50	50
TAPBIC 56	56
TAPBIC 60	60
TAPBIC 63	63

## TAPPI DURAL CON ESAGONO INCASSATO

NS. CODICE	DIAMETRO passo
------------	-------------------

TPALEI 04	8 x 1,25
TPALEI 05	10 x 1,25
TPALEI 06	10 x 1,5
TPALEI 18	12 x 1,25
TPALEI 07	12 x 1,5
TPALEI 08	14 x 1,5
TPALEI 09	16 x 1,5



NS. CODICE	DIAMETRO passo
------------	-------------------

TPALEI 10	18 x 1,5
TPALEI 11	20 x 1,5
TPALEI 12	22 x 1,5
TPALEI 13	24 x 1,5
TPALEI 14	26 x 1,5
TPALEI 15	28 x 1,5
TPALEI 16	30 x 1,5





## RONDELLE : RAME - ALLUMINIO - FIBRA

BUSTE : 100 pezzi cad. **NON SCONFEZIONABILI**

Spessore rondella 1,5 mm



DIAMETRO		
	Interno	Esterno
	mm	mm
	6	12
	8	14
	10	16
	12	18
1/4	13,5	18
	14	20
	16	22
3/8	17	23
	18	24
	20	26
1/2	21,5	27
	22	28
	24	30
3/4	26,5	32
	28	34
	30	36
	32	38
1"	33,5	40

ASSORTIMENTI IN CASSETTA contenenti 400 pz dei seguenti materiali

RAME

ALLUMINIO

FIBRA

## RONDELLE IN RAME ( sez. torica ) CON INSERTO ESENTE AMIANTO

NS. CODICE	DIAMETRO	
	Interno	Esterno
	mm	mm
RORAESAM10	10	16
RORAESAM12	12	17
RORAESAM14	14	20
RORAESAM16	16	22
RORAESAM18	18	24
RORAESAM20	20	26
RORAESAM22	22	28



# GUARNIZIONI " B O N D E D "

Sono guarnizioni a tenuta statica , costituite da un anello metallico esterno , al quale viene accoppiato all'interno, un anello trapezoidale in gomma nbr .

## LIMITI DI IMPIEGO

**Pressioni** : da 0 a 700 Bar

**Fluidi** : Olii / Grassi / Aria / Emulsioni acqua-olio / acqua - glicoli

**Temperature** : - 40°C + 100°C



NS. CODICE	GAS	DIAMETRO		spessore anello metallico
		Interno mm	Esterno mm	
BONDED05		6,86	13,21	1,22
BONDED09		8,64	14,22	1,22
BONDED11	1/8	10,37	15,88	2,00
BONDED12		11,26	18,36	2,03
BONDED13	1/4	13,74	20,57	2,00
BONDED15		14,86	22,23	2,03
BONDED17	3/8	16,51	25,40	2,03
BONDED20		17,28	23,80	2,00
BONDED24		18,16	25,40	2,50
BONDED27		19,69	26,92	2,50
BONDED33	1/2	21,54	28,58	2,00
BONDED35	5/8	23,49	31,75	2,50

NS. CODICE	GAS	DIAMETRO		spessore anello metallico
		Interno mm	Esterno mm	
BONDED39		24,26	33,27	2,50
BONDED43	3/4	27,05	34,93	2,00
BONDED46		27,82	38,61	2,50
BONDED48	7/8	30,81	38,10	2,50
BONDED50	1	33,89	42,80	2,50
BONDED52		38,96	47,75	3,38
BONDED56	1 1/4	42,93	52,38	2,50
BONDED58	1 1/2	48,44	58,60	2,50
BONDED60	1 3/4	54,89	69,85	3,38
BONDED64	2	60,58	73,03	2,50
BONDED68	2 1/4	66,68	79,50	3,38
BONDED72	2 1/2	76,08	90,17	3,38

## BONDED SERIE " C E T O P "

DIMENSIONI RACCOMANDATE DAL C.E.T.O.P. E DALLE NORME ISO 1179 PER I RACCORDI

NS. CODICE	GAS	DIAMETRO		spessore anello metallico
		Interno mm	Esterno mm	
BONDED80	1/8	10,40	14,70	1,25
BONDED81	1/4	13,85	18,70	1,25
BONDED82	3/8	17,35	22,70	1,25
BONDED83	1/2	21,65	26,70	1,25

NS. CODICE	GAS	DIAMETRO		spessore anello metallico
		Interno mm	Esterno mm	
BONDED84	3/4	27,30	32,50	1,25
BONDED85	1	34,20	39,50	2,00
BONDED86	1 1/4	42,80	49,50	2,00
BONDED87	1 1/2	48,70	55,50	2,00
BONDED88	2	60,50	68,50	2,00



## RONDELLE BOMBATE

MATERIALE :  
Acciaio per molle

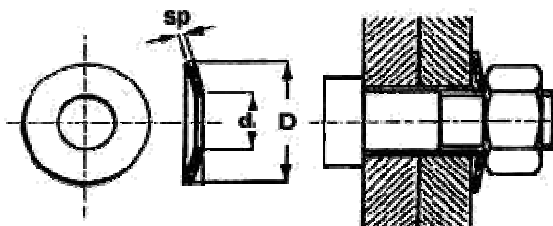

NS. CODICE	DIAMETRO	DIAMETRO	SPESSORE
	INTERNO	ESTERNO	
	mm	mm	mm
ROBO0612	6	12	1,2
ROBO0816	8	16	1,4
ROBO1020	10	20	2,6
ROBO1224	12	24	3
ROBO1432	14	32	3,5
ROBO1634	16	34	4,3
ROBO1836	18	36	4,3
ROBO2038	20	38	5,2

## RONDELLE CONICHE GROWER DIN 74361 C

NS. CODICE	DIAMETRO
	mm

ROCOGR12	12
ROCOGR14	14
ROCOGR16	16
ROCOGR18	18
ROCOGR20	20
ROCOGR22	22



## RONDELLE CONICHE SANE

NS. CODICE	DIAMETRO
	mm

ROCOSA14	14
ROCOSA16	16
ROCOSA18	18
ROCOSA20	20
ROCOSA22	22



## RONDELLE DENTELLATE ESTERNE UNI 8842 DIN 6798/A

## RONDELLE DENTELLATE INTERNE UNI 8842 DIN 6798/J

MATERIALE :  
C 70 - Acciaio per molle bonificato

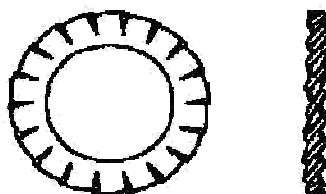

NS. CODICE INTERNE	NS. CODICE ESTERNE	DIAMETRO mm	confezione pz
RODEIN04	RODEES04	4	2000
RODEIN05	RODEES05	5	2000
RODEIN06	RODEES06	6	1750
RODEIN08	RODEES08	8	1000
RODEIN10	RODEES10	10	1000
RODEIN12	RODEES12	12	500
RODEIN14	RODEES14	14	400
RODEIN16	RODEES16	16	400
RODEIN18	RODEES18	18	350
RODEIN20	RODEES20	20	300
RODEIN22	RODEES22	22	200
RODEIN24	RODEES24	24	200
RODEIN27	RODEES27	27	100
RODEIN30	RODEES30	30	100

LE RONDELLE DENTELLATE ESTERNE SONO DISPONIBILE ANCHE ZINCATE DEIDROGENATE



## RONDELLE COMMERCIALI

MATERIALE :

Acciaio a basso tenore di carbonio

NS. CODICE	DIAMETRO INTERNO mm	DIAMETRO ESTERNO mm
------------	---------------------------	---------------------------

ROCOMM22	23	45
ROCOMM24	25	50
ROCOMM26	26	53
ROCOMM28	29	57
ROCOMM30	31	62
ROCOMM33	34	67
ROCOMM36	37	74
ROCOMM38	39	78
ROCOMM40	41	82
ROCOMM42	43	84
ROCOMM45	46	92
ROCOMM48	49	96
ROCOMM50	51	100



## RONDELLE GREMBIALINA DIN 9021

MATERIALE :

Acciaio a basso tenore di carbonio

NS. CODICE	DIAMETRO INTERNO mm	DIAMETRO ESTERNO mm
------------	---------------------------	---------------------------

ROGR0412	4	12
ROGR0416	4	16
ROGR0515	5	15
ROGR0520	5	20
ROGR0618	6	18
ROGR0624	6	24
ROGR0824	8	24
ROGR0832	8	32
ROGR0936	9	36
ROGR1030	10	30
ROGR1040	10	40
ROGR1050	10	50

NS. CODICE	DIAMETRO INTERNO mm	DIAMETRO ESTERNO mm
------------	---------------------------	---------------------------

ROGR1236	12	36
ROGR1248	12	48
ROGR1442	14	42
ROGR1456	14	56
ROGR1648	16	48
ROGR1664	16	64
ROGR1854	18	54
ROGR2060	20	60
ROGR2266	22	66
ROGR2472	24	72

**LE RONDELLE GREMBIALINA SONO DISPONIBILE SIA GREZZE CHE ZINCATE**



# SPINE ELASTICHE UNI 6873 - DIN 1481 - ISO 8752

## TIPO PESANTE

MATERIALE :

Acciaio per molle bonificato

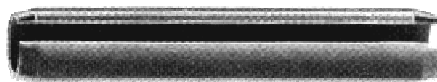

NS. CODICE	Ø foro mm	Lunghezza mm	confezione pz	
SPIEL02012	2	12	200	
SPIEL02016		16	200	
SPIEL02020		20	200	
SPIEL02030		30	200	
SPIEL25020	2,5	20	200	
SPIEL25024		24	200	
SPIEL25030		30	200	
SPIEL03010	3	10	200	
SPIEL03012		12	200	
SPIEL03014		14	200	
SPIEL03016		16	200	
SPIEL03020		20	200	
SPIEL03022		22	200	
SPIEL03024		24	200	
SPIEL03030		30	100	
SPIEL03036		36	100	
SPIEL03040		40	100	
SPIEL03050		50	100	
SPIEL04010		4	10	200
SPIEL04012			12	200
SPIEL04016	16		100	
SPIEL04018	18		100	
SPIEL04020	20		100	
SPIEL04022	22		100	
SPIEL04025	25		100	
SPIEL04030	30		100	
SPIEL04036	36		100	
SPIEL04040	40		50	
SPIEL04045	45		50	
SPIEL04050	50	50		
SPIEL05016	5	16	100	
SPIEL05020		20	100	
SPIEL05024		24	100	
SPIEL05030		30	50	
SPIEL05035		35	50	
SPIEL05040		40	50	
SPIEL05045		45	50	
SPIEL05050		50	50	
SPIEL05055		55	50	
SPIEL05060		60	50	
SPIEL05070		70	30	
SPIEL05080	80	30		
SPIEL06010	6	10	100	
SPIEL06012		12	100	
SPIEL06014		14	100	
SPIEL06016		16	100	
SPIEL06020		20	50	
SPIEL06024		24	50	

NS. CODICE	Ø foro mm	Lunghezza mm	confezione pz
SPIEL06026	6	26	50
SPIEL06030		30	50
SPIEL06036		36	50
SPIEL06040		40	50
SPIEL06045		45	50
SPIEL06050		50	50
SPIEL06060		60	30
SPIEL06070		70	30
SPIEL06080		80	30
SPIEL06090		90	20
SPIEL06100	100	20	
SPIEL07040	7	40	30
SPIEL07050		50	30
SPIEL07060		60	30
SPIEL07070		70	30
SPIEL08024	8	24	50
SPIEL08026		26	50
SPIEL08030		30	50
SPIEL08036		36	50
SPIEL08040		40	30
SPIEL08045		45	30
SPIEL08050		50	30
SPIEL08060		60	30
SPIEL08070		70	30
SPIEL08080		80	20
SPIEL08090	90	20	
SPIEL08100	100	20	
SPIEL10025	10	25	30
SPIEL10030		30	30
SPIEL10040		40	30
SPIEL10045		45	30
SPIEL10050		50	30
SPIEL10060		60	20
SPIEL10070		70	20
SPIEL10080		80	10
SPIEL10090		90	10
SPIEL10100		100	10
SPIEL12050	12	50	10
SPIEL12060		60	10
SPIEL12070		70	10
SPIEL12080		80	10
SPIEL12090		90	10
SPIEL12100		100	10
SPIEL12120	120	10	
SPIEL14070	14	70	10
SPIEL14080		80	10
SPIEL14090		90	10
SPIEL16070	16	70	10
SPIEL16080		80	10
SPIEL16090		90	10

SONO FORNIBILI SU RICHIESTA DIAMETRI SINO AL 50 E LUNGHEZZE SINO AL 200

080 532 77 24 - info@depalmtrade.it

## SPRAY TECNICI

### LINEA LUBRIFICANTI spray

#### Grasso Milleusi spray

BOMBOLETTA DA 400 ML Cod. 0572

Lubrificante universale , ha una buona resistenza al calore , non si ossida , non si altera nel tempo



#### Lubrificante PTFE spray

BOMBOLETTA DA 400 ML Cod. 0564

Lubrificante al PTFE ( Teflon ) non cola e non macchia . Indicato per giunti ,ingranaggi , cerniere , serrature guide di scorrimento tende / porte / cassetti ,elettrodomestici. La sua formulazione assicura una lubrificazione ad alte temperature e per lungo termine .

#### Olio Taglio spray

BOMBOLETTA DA 400 ML Cod. 0574

Rende più rapida e sicura la lavorazione dei metalli . Può essere impiegato per la lavorazione di qualsiasi metallo ferroso , non ferroso , e relative leghe .Non emana fumi ed è adatto per macchine manuali e automatiche. Grazie alla sua formulazione può essere asportato con acqua .

#### Olio Vasellina spray

BOMBOLETTA DA 400 ML Cod. 0571

E' una paraffina che protegge gomma,metalli,pelle,cuoio,legno ; non si ossida, non asciuga,non macchia. Indicato per lubrificare i macchinari dell'industria tessile .

#### Passacavo spray

BOMBOLETTA DA 400 ML Cod. 0577

E' uno scivolante per cavi,condotti, canalette di impianti elettrici. Non intacca la gomma e le materie plastiche. La formulazione del prodotto protegge il cavo dall'invecchiamento e dall'umidità .

#### Riattiva contatti spray

BOMBOLETTA DA 200 ML Cod. 0582

Indispensabile per lubrificare e riattivare circuiti elettrici e meccanismi vari. Garantisce il ripristino della conducibilità elettrica , espelle l'umidità , sblocca i meccanismi inceppati da ruggine ossidazione . Non danneggia la plastica e gomma . **Disattivare la tensione prima di utilizzare il prodotto .**





## SPRAY TECNICI

### LINEA LUBRIFICANTI spray

#### Silicone spray

BOMBOLETTA DA 400 ML Cod. 0562

E' un prodotto universale può essere usato come lubrificante , protettivo, distaccante, isolante per impianti elettrici , lucidante , anticongelante , idrorepellente. E' inodore non unge non contiene solventi

#### Sbloccante spray

BOMBOLETTA DA 400 ML Cod. 0573

E' un prodotto multiuso con 7 funzioni : sbloccante , protettivo , lubrificante , idrorepellente , anticongelante , sgrassante , dielettrico ; a forte potere penetrante .Non intacca metalli e gomma . **Non contiene tricloroetilene**  
Specifiche militari : MIL-C-23411 / MIL-C16173 / DEF STAN 68-10/2 / NATO C 634

#### Grasso alta Temperatura spray

BOMBOLETTA DA 400 ML Cod. 0577

E' un lubrificante antigrippaggio al **bisolfuro di mobilbdeno** che resiste alle temperature sino a 700 °C. Nel settore automobilistico trova impiego per dadi collettore , perni , giunti a balestre .

### LINEA LUBRIFICANTI liquidi

#### Olio Emulsionabile trasparente

di nuovissima concezione raccomandato per operazioni di taglio,tornitura rettificazione , foratura , fresature,maschiatura , filettatura, taglio a segha e in tutte le lavorazioni di metallo dove possono essere impiegati lubrificanti a base acquosa . Il prodotto è indicato anche per la lubrificazione delle leghe gialle di facile e media lavorabilità .

Cod. 0501

TANICA DA 5 LT

Cod. 0502

TANICA DA 25 LT



E' fornibile anche la versione BIANCA



## SPRAY TECNICI

### LINEA PROTETTIVI spray

**Acciaio inox spray** BOMBOLETTA DA 400 ML Cod. 4062

Prodotto ideale per proteggere e ripristinare i materiali in acciaio inox .  
Può essere verniciato o lasciato come protezione finale grazie all'alto contenuto di acciaio liquido

**Alluminio spray** BOMBOLETTA DA 400 ML Cod. 4063

Prodotto ideale per proteggere e ripristinare i materiali in alluminio.  
Può essere verniciato o lasciato come protezione finale grazie all'alto contenuto di alluminio .

**Antiadesivo Saldatura spray** BOMBOLETTA DA 400 ML Cod. 0576

Evita che scorie e schizzi di saldatura possano aderire alle superfici trattate .  
Le parti trattate possono essere verniciate e zincate . **NON CONTIENE SILICONE**

**Antislittante Cinghie spray** BOMBOLETTA DA 400 ML Cod. 0575

Può essere utilizzato per qualsiasi tipo di cinghia in gomma , cuoio , tessuto , nylon.  
Prolunga la durata della cinghia in quanto penetra nelle porosità , prevenendo tagli e screpolature .

**Zincante chiaro spray** BOMBOLETTA DA 400 ML Cod. 4061

Protettivo antiruggine , indicato per ripristinare zincature su saldature e proteggere dalla ruggine tutti i materiali ferrosi. Può essere sovraverniciato con qualsiasi tipo di vernice o lasciato come protezione finale .

**Protettivo Contatti spray** BOMBOLETTA DA 200 ML Cod. 0580

Protegge e preserva dall'acqua ,dalla salsedine ,dall'umidità i contatti elettrici di batterie,cavi,serrature elettriche calotte,elettrotensili. Incolore ,inodore, antiossidante . **Disattivare la tensione prima di utilizzare il prodotto**

**Lucida Cruscotto spray** BOMBOLETTA DA 400 ML Cod. 0610

Lucida il cruscotto e tutte le superfici dure interne ed esterne dell'auto, elimina l'odore di nicotina e profuma l'abitacolo . **NON CONTIENE SILICONE** .

**Lavavetri - liquido** CONTENITORE DA 250 ML Cod. 0605

Ideale per la pulizia del parabrezza , grazie all'azione sgrassante assicura un'ottima visibilità .



# GRASSO PROFESSIONALE

## Grasso professionale a base di saponi di Litio

Punto di goccia > 185°C

Temperatura ottimale d'impiego: da - 20°C a + 130°C

Resistente agli alti carichi

Cod. 0701	BARATTOLO	1 Kg
Cod. 0705	SECCHIO	5 Kg
Cod. 0720	SECCHIO	20 Kg



# DETERGENTI / SANIFICANTI / SGRASSANTI

**Detergente sgrassante pavimenti industriali** TANICA DA 4 Kg Cod. 0167

Ideale per rimuovere **sporchi tenaci** da pavimenti , banchi di lavoro ecc . Idoneo per pulizie a mano e macchine lavapavimenti .

**Detergente battericida deodorante** TANICA DA 4 Kg Cod. 0108

Prodotto ai SALI QUATERNARI d'ammonio dalla triplice azione : DETERGE - SANIFICA - DEODORA nel rispetto della normativa **H.A.C.C.P.**

**Sanificante per mezzi e raccoglitori rifiuti** TANICA DA 10 Kg Cod. 0184

Prodotto ai SALI QUATERNARI d'ammonio dalla triplice azione : DETERGE - SANIFICA - DEODORA

**Sanificante per impianti alimentari** TANICA DA 4 Kg Cod. 0110  
a base di polibiguanide cloridato

Idoneo per la disinfezione completa delle apparecchiature di mungitura e refrigerazione del latte , impianti alimentari , allevamento e lavorazione carni .Alto potere **batteriostatico** ( limita la proliferazione dei batteri ) e **battericida** ( eliminazione dei batteri )

**Bicomponente - Sgrassante** TANICA DA 10 Kg

Detergente sgrassante toglie lo sporco più tenace da macchine movimento terra ,camion , autobus, teloni e superfici esterne di ogni mezzo .Dissolve e asporta olii,grassi, residui carboniosi, smog e polvere .



**SONO FORNIBILI SU RICHIESTA SVARIATI PRODOTTI PER LA DISINFETTAZIONE / DETERGENZA CIVILE , INDUSTRIALE , OSPEDALIERA -- 080 532 77 24 - info@depalmatrade.it**



# SUPPORTI IN GHISA AUTOALLINEANTI

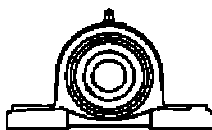

**UCP**

CODICE

UCP204
UCP205
UCP206
UCP207
UCP208
UCP209
UCP210
UCP211
UCP212
UCP213
UCP214
UCP215
UCP216
UCP217
UCP218

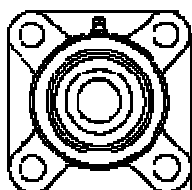

**UCF**

CODICE

UCF204
UCF205
UCF206
UCF207
UCF208
UCF209
UCF210
UCF211
UCF212
UCF213
UCF214
UCF215
UCF216
UCF217
UCF218

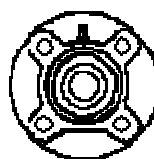

**UCFC**

CODICE

UCFC204
UCFC205
UCFC206
UCFC207
UCFC208
UCFC209
UCFC210
UCFC211
UCFC212
UCFC213
UCFC214
UCFC215

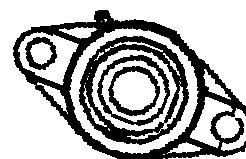

**UCFL**

CODICE

UCFL204
UCFL205
UCFL206
UCFL207
UCFL208
UCFL209
UCFL210
UCFL211
UCFL212
UCFL213
UCFL214
UCFL215
UCFL216
UCFL217
UCFL218

DIAMETRO ALBERO
20
25
30
35
40
45
50
55
60
65
70
75
80
85
90

DIAMETRO ALBERO
20
25
30
35
40
45
50
55
60
65
70
75
80
85
90

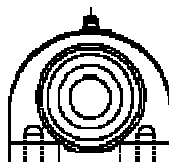

**UCPA**

CODICE

UCPA204
UCPA205
UCPA206
UCPA207
UCPA208
UCPA209
UCPA210

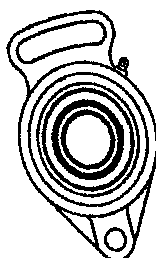

**UCFA**

CODICE

UCFA204
UCFA205
UCFA206
UCFA207
UCFA208
UCFA209
UCFA210
UCFA211
UCFA212

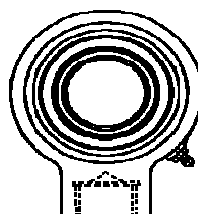

**UCHA**

CODICE

UCHA204
UCHA205
UCHA206
UCHA207
UCHA208
UCHA209
UCHA210
UCHA211
UCHA212

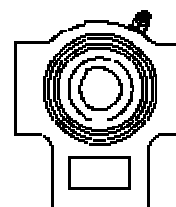

**UCT**

CODICE

UCT204
UCT205
UCT206
UCT207
UCT208
UCT209
UCT210
UCT211
UCT212
UCT213
UCT214
UCT215

DIAMETRO ALBERO
20
25
30
35
40
45
50
55
60

DIAMETRO ALBERO
20
25
30
35
40
45
50
55
60
65
70
75



## GANCI AD OCCHIO CON SICURA - ZINCATI -

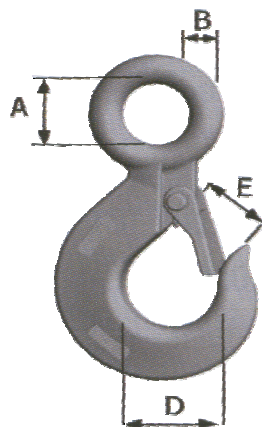

NS. CODICE

PORTATA Kg.	A mm	B mm	D mm	E mm
----------------	---------	---------	---------	---------

GANCIO0250
GANCIO0500
GANCIO1000
GANCIO1600
GANCIO2500

<b>250</b>	12	8	23	18
<b>500</b>	17	10	31	24
<b>1000</b>	20	13	41	33
<b>1600</b>	20	16	50	39
<b>2500</b>	25	20	60	49

## ANCORAGGIO CON TENDITORE A CRICCHETTO

**NASTRO IN POLIESTERE DA 50 mm CON CARICO DI ROTTURA 6000 Kg**  
**TENDITORE A CRICCHETTO CON CARICO DI ROTTURA 5000 Kg**  
**LUNGHEZZA STANDARD 9 Mt ( 8,50 fascia + 0,50 terminale )**

**TERMINALE CON GANCIO AD UNCINO**

1 gancio

**Cod.**    ANCORAGGIO 1



**TERMINALE CON GANCIO A SPONDA**

2 ganci

**Cod.**    ANCORAGGIO 2



# GOLFARI ZINCATI

## TIPO FEMMINA

DIN 582

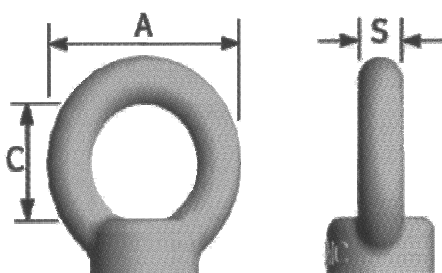

## TIPO MASCHIO

DIN 580 - UNI 2947 - ISO 3266

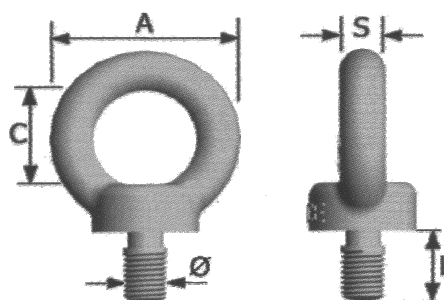

NS. CODICE	NS. CODICE
TIPO	TIPO
FEMMINA	MASCHIO

FILETTO
mm

A	C	S	L	Carico Max
mm	mm	mm	mm	Tiro diretto
				Kg

GOLFFE06	GOLFMA06
GOLFFE08	GOLFMA08
GOLFFE10	GOLFMA10
GOLFFE12	GOLFMA12
GOLFFE14	GOLFMA14
GOLFFE16	GOLFMA16
GOLFFE18	GOLFMA18
GOLFFE20	GOLFMA20
GOLFFE22	GOLFMA22
GOLFFE24	GOLFMA24
GOLFFE27	GOLFMA27
GOLFFE30	GOLFMA30
GOLFFE36	GOLFMA36

6
8
10
12
14
16
18
20
22
24
27
30
36

36	20	8	15	70
36	20	8	15	140
45	25	10	18	210
54	30	12	22	320
54	30	12	24	450
63	35	14	26	700
76	40	17	28	820
76	40	17	30	1100
80	50	20	38	1400
90	50	20	38	1700
98	54	22	38	2600
108	60	24	45	3500
126	70	28	54	5000

IL CARICO RIPORTATO E' INDICATIVO , FA' FEDE IL VALORE STAMPATO SUL PEZZO

PER LE CARATTERISTICHE TECNICHE - MECCANICHE CONSULTATE LE SCHEDE A FINE CATALOGO





## GRILLI DIRITTI TIPO LARGO ZINCATI

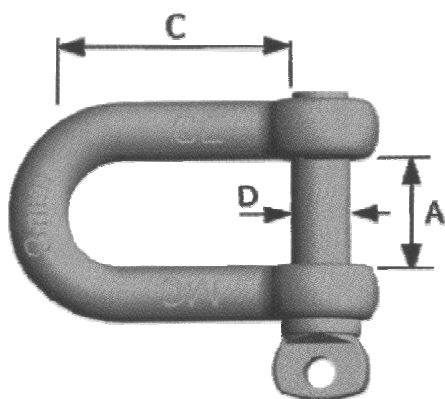

**NON ADATTI AL SOLLEVAMENTO**

NS. CODICE	D = perno		A mm	C mm	Carico Lav. Kg.
	mm	pollici			
GRILLO05	5	3/16	11	16	
GRILLO06	6	1/4	14	22	90
GRILLO08	8	5/16	16	30	200
GRILLO10	10	3/8	19	38	300
GRILLO11	11	7/16	23	44	400
GRILLO12	12	1/2	25	49	500
GRILLO14	14	9/16	29	56	600
GRILLO16	16	5/8	32	65	800
GRILLO18	18	11/16	38	69	900
GRILLO20	20	3/4	37	71	1100
GRILLO22	22	7/8	43	84	
GRILLO24	24 / 25	1"	50	94	
GRILLO28	28	1+1/8	57	115	
GRILLO32	32	1+1/4	64	118	
GRILLO38	38	1+1/2	67	124	
GRILLO45	45	1+3/4	85	170	

IL CARICO DI LAVORO RIPORTATO E' INDICATIVO , FA' FEDE IL VALORE STAMPATO SUL PEZZO

SONO FORNIBILI SU RICHIESTA I GRILLI AD ELEVATA RESISTENZA ( PERNO ROSSO )

080 532 77 24 - [info@depalmatrade.it](mailto:info@depalmatrade.it)



## MORSETTO ZINCATO PER FUNE - BASE GHISA

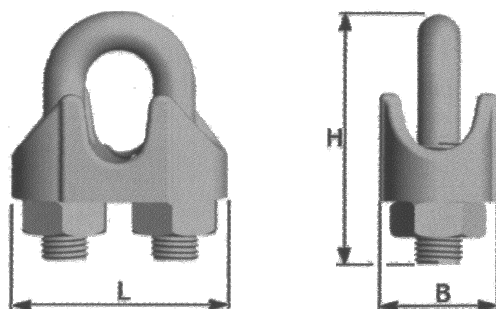

NS. CODICE
------------

Ø FUNE		H mm	L mm	B mm
mm	pollici			

MORSETTO05
MORSETTO06
MORSETTO08
MORSETTO10
MORSETTO11
MORSETTO12
MORSETTO14
MORSETTO16
MORSETTO20
MORSETTO22
MORSETTO24
MORSETTO30
MORSETTO32
MORSETTO34
MORSETTO40

5	3/16	24	22	11
6	1/4	28	26	12
8	5/16	35	30	14
10	3/8	42	34	18
11	7/16	44	37	20
12	1/2	55	40	23
14	9/16	55	44	24
16	5/8	63	52	26
20	3/4	75	53	28
22	7/8	86	60	33
24	1	93	66	36
30	1"+ 3/16	110	75	38
32	1"+ 1 / 4	110		
34	1"+ 1 / 2	120	81	42
40	1 + 9/16	140	90	45

SONO FORNIBILI SU RICHIESTA I MORSETTI " BASE FERRO " AD ELEVATA RESISTENZA

080 532 77 24 - [info@depalmatrade.it](mailto:info@depalmatrade.it)



## TENDITORI ZINCATI 2 OCCHI

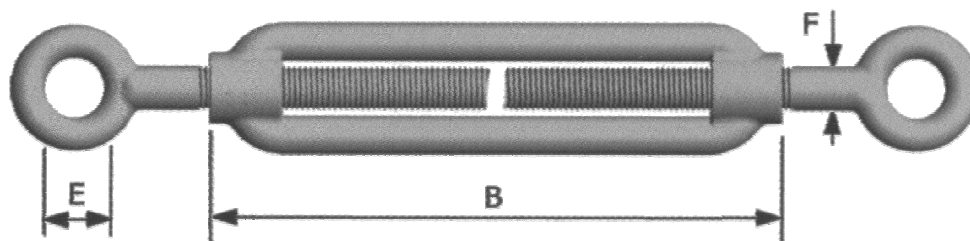

NON ADATTI AL SOLLEVAMENTO

NS. CODICE	F = perno		B mm	E mm	Carico Lav. Kg.
	mm	pollici			
TENDOO05	5	3/16	75	8	90
TENDOO06	6	1/4	89	9,5	110
TENDOO08	8	5/16	104	11	140
TENDOO10	10	3/8	133	18	260
TENDOO12	12	1/2	140	18	400
TENDOO14	14	9/16	170	18	500
TENDOO16	16	5/8	178	23	800
TENDOO18	18	11/16	198	24,5	700
TENDOO20	20	3/4	218	24,5	900
TENDOO22	22	7/8	242	30	910
TENDOO24	24	1"	262	35	1040
TENDOO28	28	1" + 1/8			
TENDOO32	32	1" + 1/4	285	37	

SONO FORNIBILI SU RICHIESTA I TENDITORI GANCIO-GANCIO E GANCIO - OCCHIO

080 532 77 24 - [info@depalmatrade.it](mailto:info@depalmatrade.it)

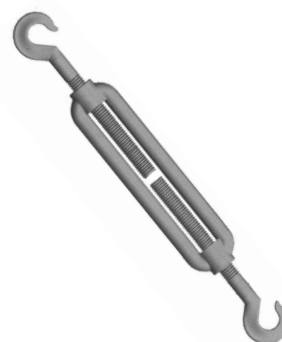

# TUBI PER CARBURANTI

## TUBO GOMMA

Tubo mandata carburanti ed olii minerali , in gomma nbr conduttivo con sottostrato liscio nero , rinforzo con inserzioni tessili e copertura esterna in gomma nbr/pvc liscia nera , resistente agli olii ai carburanti , agli agenti atmosferici e all'ozono .

Applicazione : mandata di olii minerali . gasolio e carburanti con contenuto aromatico fino al 50 % .

Temperature d'esercizio : - 30 °c + 80 °c .

NS. CODICE	DIAMETRO
TG 0410	4 x 10
TG 0613	6 x 13
TG 0815	8 x 15
TG 1017	10 x 17
TG 1320	13 x 20
TG 1523	15 x 23
TG 1927	19 x 27
TG 2535	25 x 35

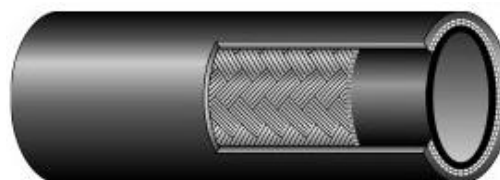

## TUBO PVC

Tubo in miscela speciale di pvc resistente agli idrocarburi.

Ottima flessibilità alle basse temperature .

Ottima trasparenza , senza rinforzo tessile .

Applicazioni : idoneo per passaggio di benzina, gasolio ed idrocarburi in genere .

Temperatura d'impiego : -20°c + 65°c - Colorato t rasparente .

Non utilizzare con acqua calda

NS. CODICE	DIAMETRO
TB 0509	5 x 9
TB 0712	7 x 12



# TUBO GOMMA PER RADIATORI

## TUBO GOMMA PASSAGGIO ACQUA CALDA

Tube in EPDM rubber with smooth black substrate resistant to heat, reinforced with fabric inserts and external EPDM black rubber coating, resistant to abrasion, aging, heat and atmospheric agents.

Applications: hot water and multiple fluids with medium aggressiveness.

Used as a flexible connection in engine cooling and heating circuits of vehicles.

Operating temperature: - 40°C + 120 °C

NS. CODICE	DIAMETRO
TA 0815	8 x 15
TA 1017	10 x 17
TA 1320	13 x 20
TA 1623	16 x 23
TA 1824	18 x 24
TA 2026	20 x 26
TA 2228	22 x 28
TA 2532	25 x 32
TA 2836	28 x 36
TA 3038	30 x 38
TA 3240	32 x 40
TA 3543	35 x 43
TA 3847	38 x 47
TA 4049	40 x 49
TA 4251	42 x 51
TA 4554	45 x 54
TA 5161	51 x 61
TA 5565	55 x 65
TA 6070	60 x 70
TA 6575	65 x 75
TA 7080	70 x 80
TA 8090	80 x 90
TA 90100	90 x 100

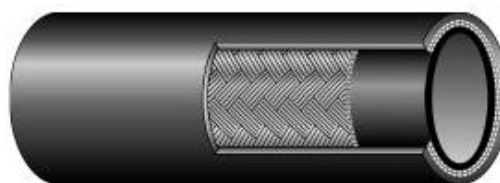

# TUBI VARI USI

## TUBO GOMMA PASSAGGIO ARIA

Tubo in gomma epdm con sottostrato liscio nero resistente al calore, rinforzo con inserzioni tessili e copertura esterna in gomma epdm nera, resistente all'abrasione, all'invecchiamento al calore ed agli agenti atmosferici.

Applicazioni: mandata aria .

Temperature d'esercizio : - 30°c + 70 °c

Pressione di Esercizio : 20 bar

Pressione di Scoppio : 60 bar

NS. CODICE	DIAMETRO
TAR 0614	6 x 14
TAR 0817	8 x 17
TAR 1019	3/8 - 10 x 19
TAR 1323	1/2 - 13 x 23
TAR 1930	3/4 - 19 x 30
TAR 2537	1 " - 25 x 37

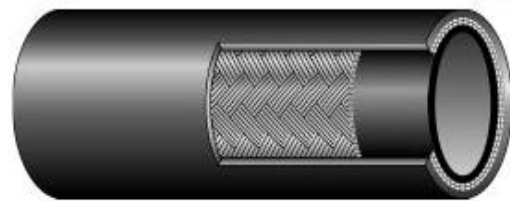

## TUBO PVC PER IRRORAZIONE

Tubo in PVC flessibile rinforzato con filato in poliestere ad alta resistenza .  
Adatto per equipaggiamento di pompe per irrorazione con insetticidi e antiparassitari.

Temperatura d'esercizio - 10°c + 60°c



NS. CODICE	DIAMETRO	PRESSIONE di ESERCIZIO	PRESSIONE di SCOPPIO	COLORE TUBO
TIR 250813	8 x 13	25 bar	75 bar	ARANCIONE
TIR 251015	10 x 15	25 bar	75 bar	ARANCIONE
TIR 251319	13 x 19	25 bar	75 bar	ARANCIONE
TIR 251623	16 x 23	25 bar	75 bar	ARANCIONE
TIR 251926	19 x 26	25 bar	75 bar	ARANCIONE
TIR 252534	25 x 34	25 bar	75 bar	ARANCIONE
TIR 500814	8 x 14	50 bar	150 bar	ARANCIONE
TIR 501016	10 x 16	50 bar	150 bar	ARANCIONE
TIR 501321	13 x 21	50 bar	150 bar	ARANCIONE
TIR 800815	8 x 15	80 bar	240 bar	BLU
TIR 801018	10 x 18	80 bar	240 bar	BLU
TIR 1000816	8 x 16	100 bar	300 bar	BLU
TIR 1001019	10 x 19	100 bar	300 bar	BLU
TIR 1001323	13 x 23	100 bar	300 bar	BLU



# VITI ARATRO TESTA GRANDE

## COMPLETI DI DADI MEDI

UNI 6104 -- DIN 605



**CLASSE 4.8**

DIAMETRO VITE ( d )	<b>10</b>	<b>12</b>	<b>14</b>	<b>16</b>	<b>20</b>	DIAMETRO VITE ( d )
DIAMETRO TESTA ( D )	20	24	28	32	36	DIAMETRO TESTA ( D )
LUNGHEZZA	<b>P E Z Z I per CONFEZIONE</b>					LUNGHEZZA
<b>30</b>	200	100				<b>30</b>
<b>35</b>	200	100	100			<b>35</b>
<b>40</b>	100	100	50	50	50	<b>40</b>
<b>45</b>	100	100	50	50	50	<b>45</b>
<b>50</b>	100	100	50	50	50	<b>50</b>
<b>60</b>	100	100	50	50	50	<b>60</b>
<b>70</b>	100	50	50	50	50	<b>70</b>
<b>80</b>	100	50	50	50	50	<b>80</b>
<b>90</b>	100	50	50	50	50	<b>90</b>

 MATERIALE LA CUI CONSEGNA E' DA COMUNICARE

E' FORNIBILE LA UNI 6105 BULLONI TESTA SVASATA CON NASELLO .





# VITI ARATRO TESTA RIDOTTA ( TIPO NARDI ) COMPLETI DI DADI MEDI

MATERIALE :  
Acciaio classe 8.8

TRATTAMENTO SUPERFICIALE :  
Brunitura

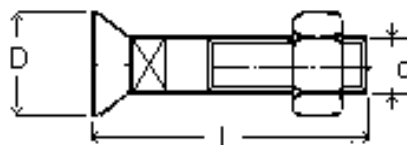

Svasatura testa : 120 °

## FILETTATURA DESTRA

NS. CODICE	Ø	L	D
	VITE		TESTA
VTDX1230	<b>12</b>	30	20
VTDX1235		35	20
VTDX1240		40	20
VTDX1245		45	20
VTDX1250		50	20
VTDX1260		60	20
VTDX1270		70	20
VTDX1280		80	20
VTDX1290		90	20

VTDX1430	<b>14</b>	30	23
VTDX1435		35	23
VTDX1440		40	23
VTDX1445		45	23
VTDX1450		50	23
VTDX1460		60	23
VTDX1470		70	23
VTDX1480		80	23

NS. CODICE	Ø	L	D
	VITE		TESTA
VTDX1640	<b>16</b>	40	26
VTDX1645		45	26
VTDX1650		50	26
VTDX1660		60	26
VTDX1670		70	26
VTDX1680		80	26



## FILETTATURA SINISTRA

NS. CODICE	Ø	L	D
	VITE		TESTA
VTSX1230	<b>12</b>	30	20
VTSX1235		35	20
VTSX1240		40	20
VTSX1245		45	20
VTSX1250		50	20

VTSX1435	<b>14</b>	35	23
VTSX1440		40	23
VTSX1445		45	23
VTSX1450		50	23

NS. CODICE	Ø	L	D
	VITE		TESTA
VTSX1635	<b>16</b>	35	26
VTSX1640		40	26
VTSX1645		45	26
VTSX1650		50	26
VTSX1660		60	26

## VITI TESTA ESAGONALE x ZAPPETTE

TRATTAMENTO SUPERFICIALE :  
**Brunitura**

NS. CODICE	Ø	Lunghezza	PASSO	LUNGHEZZA	Resistenza
	VITE			FILETTATURA	
VTZAPP 02	<b>10</b>	<b>30</b>	1,5	15	<b>8.8</b>
VTZAPP 07	<b>12</b>	<b>35</b>	1,25	18	<b>8.8</b>
VTZAPP 10	<b>14</b>	<b>40</b>	1,5	20	<b>8.8</b>
VTZAPP 11	<b>16</b>	<b>45</b>	1,5	25	<b>8.8</b>
VTZAPP 12	<b>7/16</b>	1" 1/4 (32)	20 UNF	19	<b>8.8</b>
VTZAPP 13	<b>1/2</b>	1" 1/2 (38)	20 UNF	21	<b>8.8</b>
VTZAPP 15	<b>14</b>	<b>40</b>	1,5	20	<b>10.9</b>
VTZAPP 14	<b>16</b>	<b>47</b>	1,5	25	<b>10.9</b>
VTZAPP 17	<b>16</b>	<b>50</b>	1,5	25	<b>12.9</b>
VTZAPP 18	<b>16</b>	<b>57</b>	1,5	28	<b>12.9</b>

cpt  
cpt  
cpt



**cpt = VITE COMPLETA DI DADO ALTO E RONDELLA GROWER RINFORZATA**

## VITI TESTA OLIVA ( OVALE ) QUADRO SOTTO TESTA CON DADO MEDIO

MATERIALE :  
 Acciaio classe 8.8

NS. CODICE	Ø	Lunghezza	PASSO
	VITE		
VTZAPP 16	<b>10</b>	<b>38</b>	1,5



LA LUNGHEZZA RIPORTATA E' COMPENSIVA DI TESTA

VITE TUTTO FILETTO



# VITI TESTA TONDA QUADRO SOTTO TESTA

UNI 5731 -- Res. 8.8

MATERIALE :  
Acciaio classe 8.8

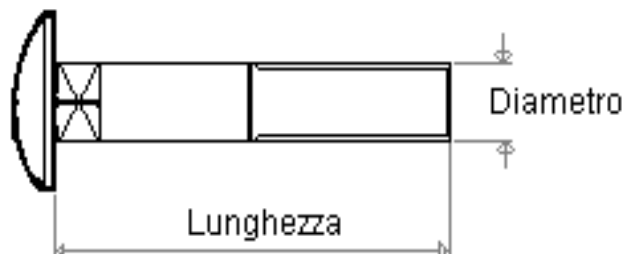

TRATTAMENTO SUPERFICIALE :  
Brunitura

NS. CODICE

Ø	L
VITE	

573108016
573108020
573108025
573108030
573108035
573108040
573108045
573108050

<b>8</b>	16
	20
	25
	30
	35
	40
	45
	50

NS. CODICE

Ø	L
VITE	

573112030
573112035
573112040
573112045
573112050
573112060
573112070
573112080
573112090

<b>12</b>	30
	35
	40
	45
	50
	60
	70
	80
	90

573110025
573110030
573110035
573110040
573110045
573110050
573110060
573110070
573110080

<b>10</b>	25
	30
	35
	40
	45
	50
	60
	70
	80



Zincato su richiesta



# PRODOTTI PER LA DISINFESTAZIONE / DERATTIZZAZIONE

## CONTROLLO DEGLI INSETTI

ZANZARE / BLATTE / FORMICHE / MOSCHE / VESPE / ACARI / LEPIDOTTERI

VARIE FORMULAZIONI CON I SEGUENTI PRINCIPI ATTIVI

CIPERMETRINA - TETRAMETRINA - DELTAMETRINA - PERMETRINA - DICLORVOS

C.PHENOTHRIN - IMIDACLOPRID - BENDIOCARB - ETOFENPROX

DIFLUBENZURON - PIRETRO NATURALE



## CONTROLLO DEI RODITORI

VARIE FORMULAZIONI CON I SEGUENTI PRINCIPI ATTIVI

DIFENACOUM - BRODIFACOUM - BROMADIOLONE



## PRODOTTI COMPLEMENTARI

EROGATORI DI ESCHE - LAMPADE ATTRATTIVE - NEBULIZZATORI - MOTOPOMPE - ATOMIZZATORI



PER RICEVERE IL CATALOGO COMPLETO DISINFESTAZIONE CONTATTATE

IL NS. AGENTE DI ZONA O INVIATECI RICHIESTA A [INFO@DEPALMATRADE.IT](mailto:INFO@DEPALMATRADE.IT)



# LAMPADE AUTO / CAMION



**ALOGENE**



**EFFETTO XENON**



**GAS XENON**



**ANGEL EYES**

**LED : FENDINEBBIA - FRECCHE - TARGA - CRUSCOTTO - PORTIERE - ABITACOLO - POSIZIONE**



**CENTRALINE XENON**



**BOBINE LED - TRASFORMATORI**

**PER RICEVERE IL CATALOGO COMPLETO DELLE LAMPADE CONTATTATE**

**IL NS. AGENTE DI ZONA O INVIATECI RICHIESTA A [INFO@DEPALMATRADE.IT](mailto:INFO@DEPALMATRADE.IT)**





## LAMPADINE LED PER ABITAZIONE / INDUSTRIA



DISPONIBILI TUTTE LE TIPOLOGIE DI ATTACCO



VARI TIPI DI APPLIQUE - FARETTI DA INCASSO IN VARI FORMATI



VARIE TIPOLOGIE DI RUBINETTI CON LED

IL COLORE DELLA LUCE EMessa DAI LED VARIA CON  
IL VARIARE DELLA TEMPERATURA DELL'ACQUA



ILLUMINAZIONE LED INDUSTRIALE - FOTOVOLTAICO LED - EOLICO/FOTOVOLT. LED

PER RICEVERE IL CATALOGO COMPLETO DELLE LAMPADINE CONTATTATE

IL NS. AGENTE DI ZONA O INViateCI RICHIESTA A [INFO@DEPALMATRADE.IT](mailto:INFO@DEPALMATRADE.IT)

# GOLFARI DIN 580 -- DIN 582

## ISTRUZIONI PER L'USO CORRETTO

**1)** Avvitare a fondo il golfare. Le portate massime di carico si riferiscono a golfari ben serrati all'oggetto da sollevare (**condizione essenziale di sicurezza**). Utilizzando per il serraggio leve o mezzi meccanici, assicuratevi di non causare sovratensioni nel gambo. Mettete in tensione le funi e/o i ganci prima di iniziare il sollevamento.

**2)** Nel sollevamento con 2 golfari la portata massima indicata sui golfari non è più valida. La portata massima per il tiro inclinato è indicata nelle tabelle di seguito riportate. Non superate mai i 45 gradi tra l'asse del golfare e la fune di tiro. Allineate gli anelli con un corretto serraggio o per mezzo di rondelle di spessore che abbiano almeno lo stesso diametro del piano di appoggio dei golfari .

**3) I golfari non possono essere avvitati ai lati dell'oggetto da sollevare.** Questo tipo di utilizzo non è previsto dalle norme di prodotto. Per il golfare l'angolo di tiro non deve mai superare i 45° tra l'asse del golfare e la fune di tiro.

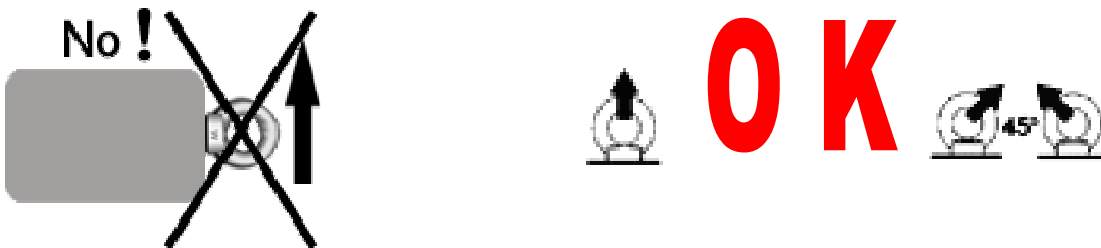

**4)** Le portate massime di carico si riferiscono ad una temperatura di utilizzo tra -10°C e + 40°C (+14°F/+104°F).

**5)** Ad ogni riutilizzo dei golfari, controllate visivamente che non siano presenti difetti, quali ammaccature, cricche, bave taglienti, deformazioni, filetti strappati o mancanti, ruggine o segni evidenti di scorretto stoccaggio che potrebbero compromettere la sicurezza.

**6)** Rispettate le normative di sicurezza vigenti nel vostro Stato relative alle modalità di utilizzo delle apparecchiature e/o organi di sollevamento.





## CARATTERISTICHE TECNICHE - MECCANICHE

Il carico di sicurezza delle misure standard è stabilito dalle norme DIN secondo le quali sono costruiti i golfari.

La portata per la stessa misura di golfare varia tra:



**carico a tiro dritto:** applicato a 1 golfare (coassiale all'asse del filetto)



**carico a tiro inclinato:** applicato a 2 golfari con un'inclinazione massima di 45° gradi tra l'asse del golfare e la fune di tiro.



### DIN 580 golfare maschio con filettatura metrica passo grosso e passo fine



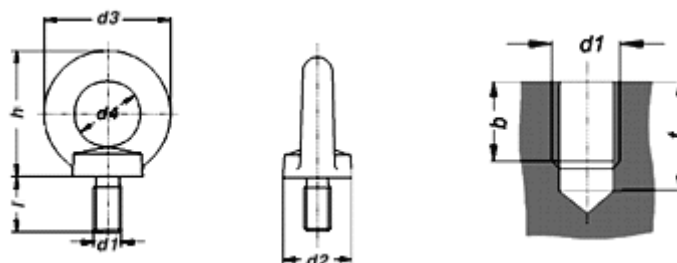

d1 mm	d2	A d3	C d4	h	L l	T <sub>max</sub> 	
							
	mm	mm	mm	mm	mm		
<b>M 8</b>	20	36	20	36	15	0,14	0,095
<b>M 10</b>	25	45	25	45	18	0,23	0,17
<b>M 12</b> M 12x1,5	30	54	30	53	22	0,34	0,24
<b>M 16</b> M 16x1,5	35	63	35	62	26	0,7	0,5
<b>M 20</b> M 20x1,5	40	72	40	71	30	1,2	0,83
<b>M 24</b> M 24x2	50	90	50	90	38	1,8	1,27
<b>M 30</b> M 30x2	65	108	60	109	45	3,6	2,6
<b>M 36</b> M 36x3	75	126	70	128	54	5,1	3,7
<b>M 42</b> M 42x3	85	144	80	147	63	7	5
<b>M 48</b> M 48x3	100	166	90	168	68	8,6	6,1
<b>M 56</b> M 56x4	110	184	100	187	78	11,5	8,3
<b>M 64</b> M 64x4	120	206	110	208	90	16	11
<b>M 72</b> M 72x4	150	260	140	260	100	21	15
<b>M 80</b> M 80x4	170	296	160	298	112	28	20
<b>M 100</b> M 100x4	190	330	180	330	130	38	27



d1	8	10	12	16	20	24	30	36	42	48	56	64	72	80	100
b min	15	18	22	26	30	38	45	54	63	68	78	90	100	112	130
t min	18,5	22,5	26,5	33,5	37,5	44,5	55	65	75	81	93	106	116	128	146



## DIN 582 golfare femmina con filettatura metrica passo grosso e passo fine

d1 mm	d2	A d3	C d4	h	e	 <b>T<sub>max</sub></b>	
	mm	mm	mm	mm	mm		
<b>M 8</b>	20	36	20	36	8,5	0,14	0,095
<b>M 10</b>	25	45	25	45	10	0,23	0,17
<b>M 12</b>	30	54	30	53	11	0,34	0,24
<b>M 16</b>	35	63	35	62	13	0,70	0,50
<b>M 20</b> M 20x1,5	40	76	40	71	16	1,2	0,83
<b>M 24</b> M 24x2	50	90	50	90	20	1,8	1,27
<b>M 30</b> M 30x2	65	108	60	109	25	3,6	2,6
<b>M 36</b> M 36x3	75	126	70	128	30	5,1	3,7
<b>M 42</b> M 42x3	85	144	80	147	35	7,0	5,0
<b>M 48</b> M 48x3	100	166	90	168	40	8,6	6,1

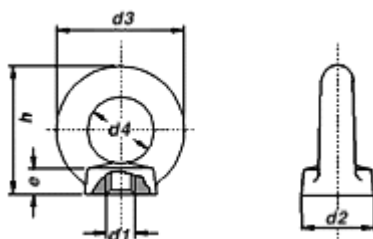

### RESPONSABILITA' - GARANZIE

In base alla direttiva 85/374/CEE in materia di responsabilità per danno da prodotti difettosi, la responsabilità del fabbricante è implicata soltanto se il prodotto era difettoso sin dall'origine ed è attenuata, se non soppressa, se l'utilizzatore non si attiene alle istruzioni d'uso ed a quanto indicato nelle tabelle di prodotto. La direttiva macchine impone certe regole al costruttore, ma nello stesso tempo obbliga gli utilizzatori, ad assicurarsi al momento dell'acquisto che il prodotto sia conforme a tale direttiva.

### MARCATURE

La direttiva macchine e le norme di prodotto prevedono che ogni " accessorio per il sollevamento " , marcato CE , debba avere le seguenti marcature :

- dimensione filettatura
- identificazione del materiale
- identificazione del carico massimo di utilizzazione a tiro diretto espressa in tonnellate
- identificazione del fabbricante
- marcatura CE



## CONDIZIONI GENERALI DI VENDITA

### 1. PREZZI

I prezzi riportati sul listino allegato , potranno essere assoggettati a variazioni senza obbligo di preavviso alcuno da parte della **DE PALMA TRADE** .

### 2. CONSEGNE

Il termine di consegna , se fissato , ha valore indicativo ed un eventuale ritardo , non pregiudica la validità dell'ordine .

### 3. PAGAMENTO

La **DE PALMA TRADE** si riserva in qualsiasi momento di sospendere le forniture qualora ravvisasse nel committente delle insolvenze . Eventuali contestazioni per difetti di merce ricevuta , o ritardi di fornitura , non possono costituire motivo di sospensione dei pagamenti del fatturato ; salvo che per la sola parte attinente alla contestazione .

### 4. RECLAMI - RESI

Trascorsi 8 giorni dal ricevimento merce , non si accetteranno resi , se non da noi preventivamente autorizzati ; i reclami non sospenderanno l'obbligo di effettuare i pagamenti secondo la forma convenuta. La merce dovrà essere spedita in PORTO FRANCO ns sede e accompagnata dal documento di trasporto che dovrà recare gli estremi del ns documento di vendita e fattura .

### 5. DATI TECNICI

Dati , descrizioni , illustrazioni riportati nel seguente catalogo , non sono impegnativi e nessuna responsabilità potrà derivare alla **DE PALMA TRADE** per effetto di loro modifiche, sostituzioni o migliorie che potranno essere effettuate anche senza preavviso .

### 6. GARANZIA

I ns prodotti sono garantiti secondo le norme vigenti ; verranno quindi sostituiti o riparati i pezzi difettosi , ma non quelli che presenteranno inconvenienti dovuti al normale logorio , errato uso , manomissione o garanzia scaduta . La merce dovrà essere spedita in PORTO FRANCO ns sede e accompagnata dal documento di trasporto che dovrà recare il numero di matricola , se presente , e gli estremi del ns documento di vendita e fattura per usufruire della garanzia .

**DE PALMA TRADE** srl .

## SALE GENERAL TERMS

### 1 . PRICES

The prices reported on the enclosed list , could be subjected to any changes by **DE PALMA TRADE** without being obliged to give any advance notice .

### 2. DELIVERY

The delivery date ,when fixed , has a relative value and any delay does not compromise the validity of the order .

### 3. PAYMENT

**DE PALMA TRADE** reserves the right to suspend at any time the supplies if they should see some insolvencies from the customer. Possible contestations for any defects of the goods received or for any delay in the supplying , cannot be a reason for stopping the billing payment except just what regards the part related to the contestation.

### 4. COMPLAINTS – RETURNS

Once they will be passed 8 days since the receiving of the goods , no returns will be accepted , unless we had previously permitted them. Complaints will not suspend the obligation to effect the payments according to the agreed form . The goods will be sent carriage paid to our seat and will be accompanied with the carriage document that will bear the data of our sale document and invoice .

### 5. TECHNICAL DATA

The descriptions , illustrations and data reported on this catalogue are not binding and no liability will be due to **DE PALMA TRADE** because of any alteration , replacement or improvement that could be realized also without any advance notice .

### 6. GUARANTEE

Our products are guaranteed according to the regulations in force .Therefore they will be replaced or repaired defective parts and not those ones that will present some drawbacks due to the normal wear , wrong use ,tampering or expired guarantee .The goods will be sent carriage paid to our seat and accompanied with the carriage document that will bear the registration number , if present , and the data of our sale document and invoice in order to benefit by the guarantee .

**DE PALMA TRADE** srl

## COME RAGGIUNGERCI

Provenienza	S.S. 16	BARITANG. - USCITA 7B Z.I. MODUGNO
Provenienza	S.S. 16 Bis	BARITANG. - USCITA 6 Z.I. MODUGNO
Provenienza	S.S. 100	BARITANG. x FOGGIA / MATERA -- USCITA 7B Z.I. MODUGNO
Provenienza	A 14 BARI Sud	BARITANG. x FOGGIA -- USCITA 7B Z.I. MODUGNO
Provenienza	A 14 BARI Nord	BARITANG. x FOGGIA



## DE PALMA TRADE SRL

S.P. 231 ( ex S.S. 98 ) Km 0 + 850 - MODUGNO ( BA )

080 532 71 98 // 080 532 77 24

[WWW.DEPALMATRADE.IT](http://WWW.DEPALMATRADE.IT) - [INFO@DEPALMATRADE.IT](mailto:INFO@DEPALMATRADE.IT)

